

Seam allowance 1/2in.

ADIES'IT  
size

Bonding line Aa



Bonding line AA

Bonding line AA

Zip position

Bonding line Ba

Bonding line AB

Dart

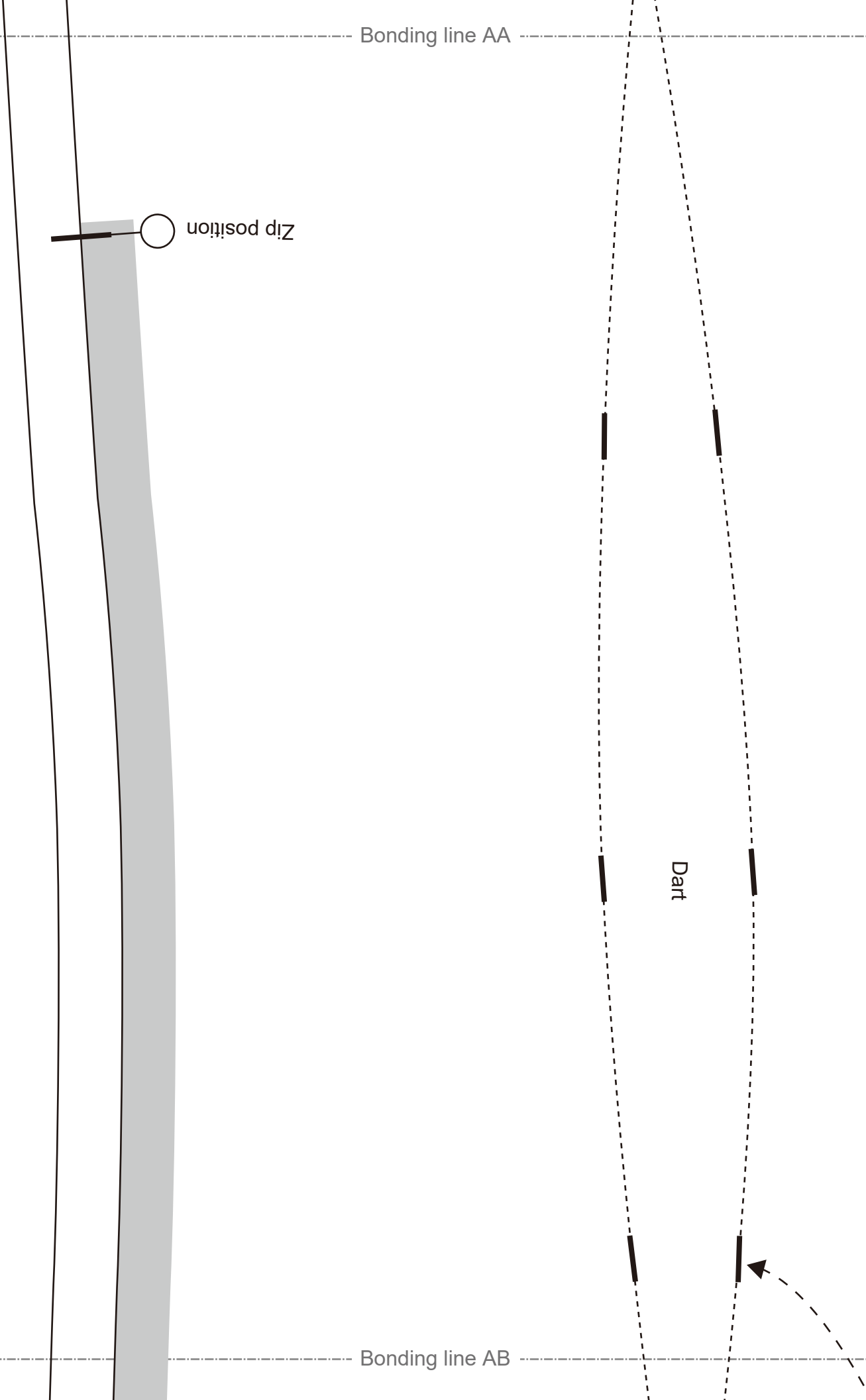

Short One-piece Dress  
Back Body  
two sheets

Fusible Stay tape

Bonding line AB

Bonding line AC

Bonding line Ca

Baste



Bonding line AC

<https://www.facebook.com/drcos.com>  
<https://twitter.com/drcos.com>  
[info@drcos.com](mailto:info@drcos.com)  
<http://drcos.info/en> <http://drcos.com/pt>

**DRCOS**

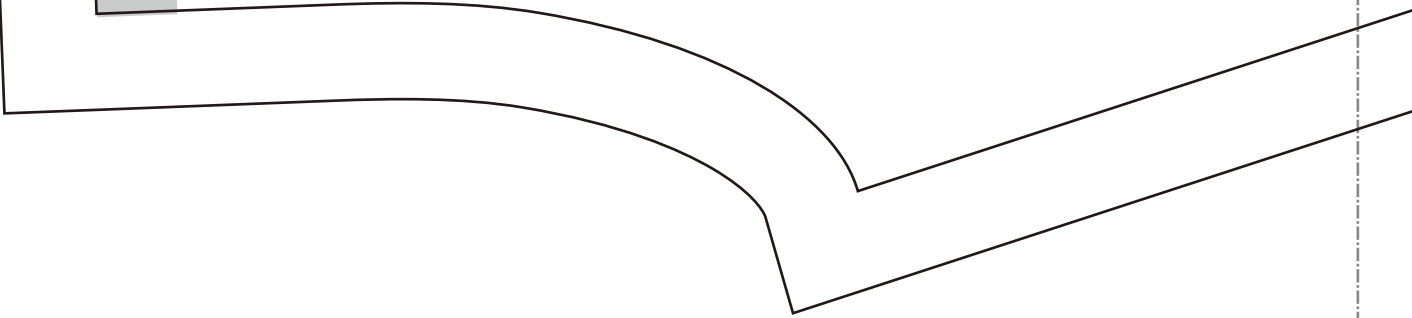

Bonding line Da

Bonding line AD

W

Bonding line Aa

Bonding line BA

Bonding line Ab

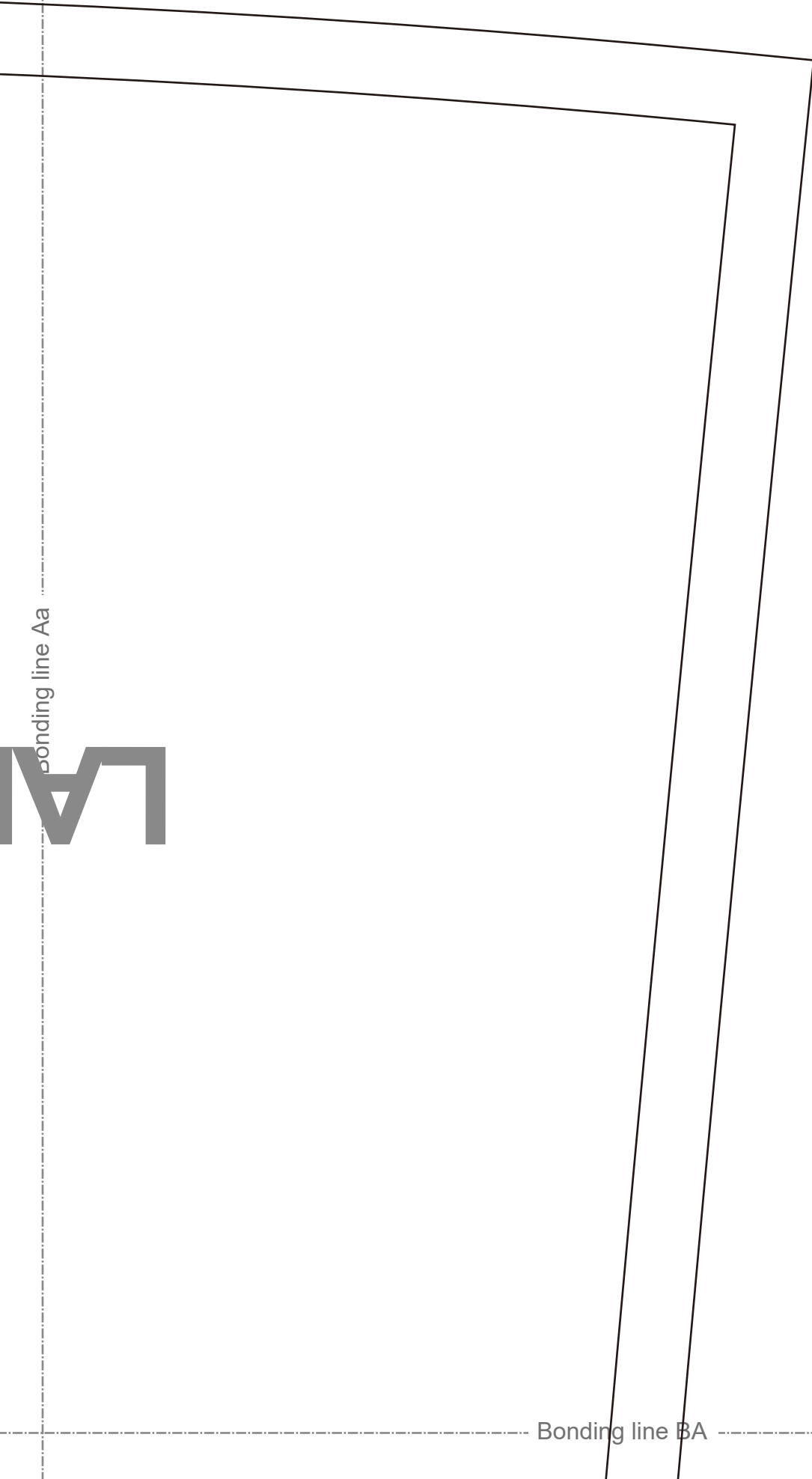



Bonding line BA

Bonding line Ba

Bonding line Bb

Grain Line

Bonding line BB

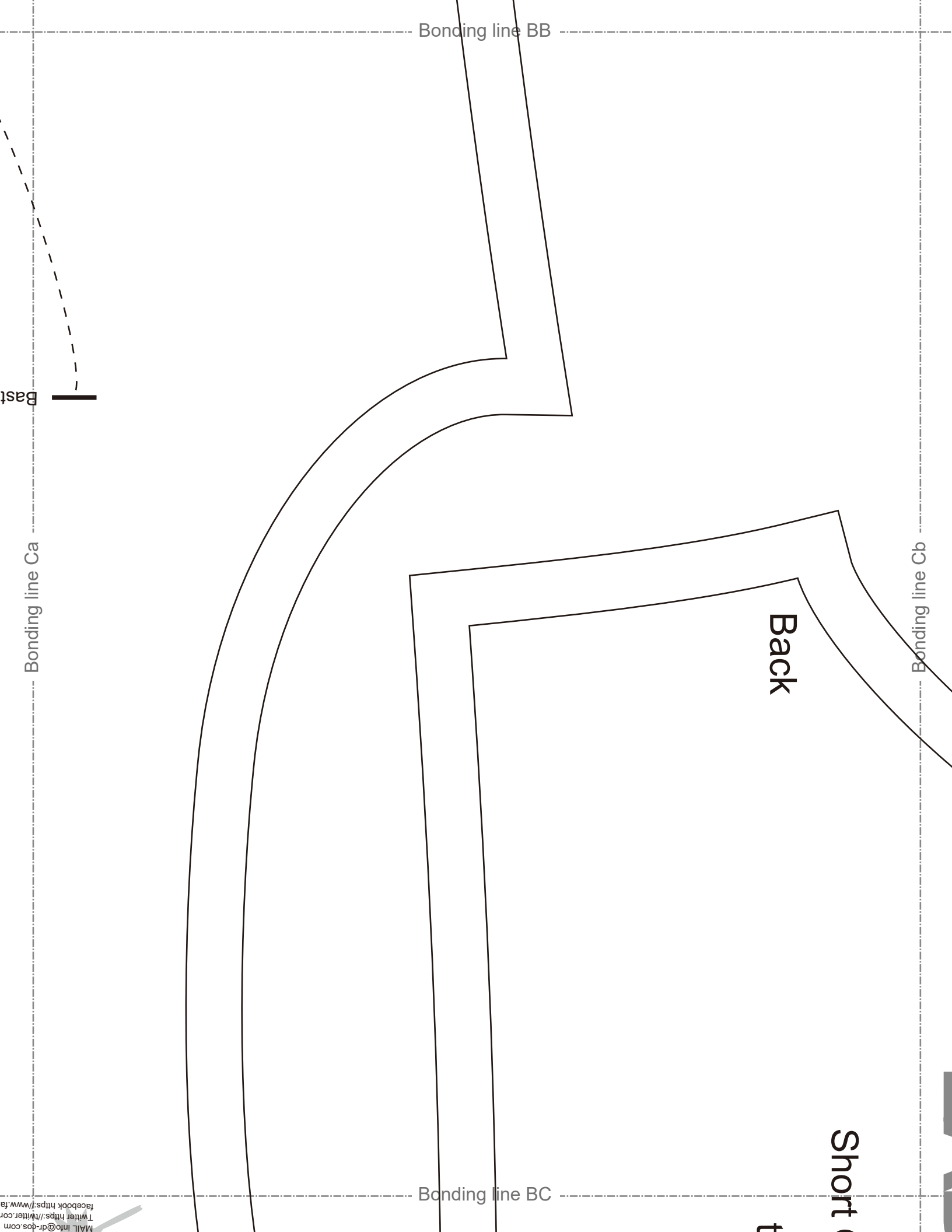



# Short One-piece Dress

## Sleeve

### two sheets

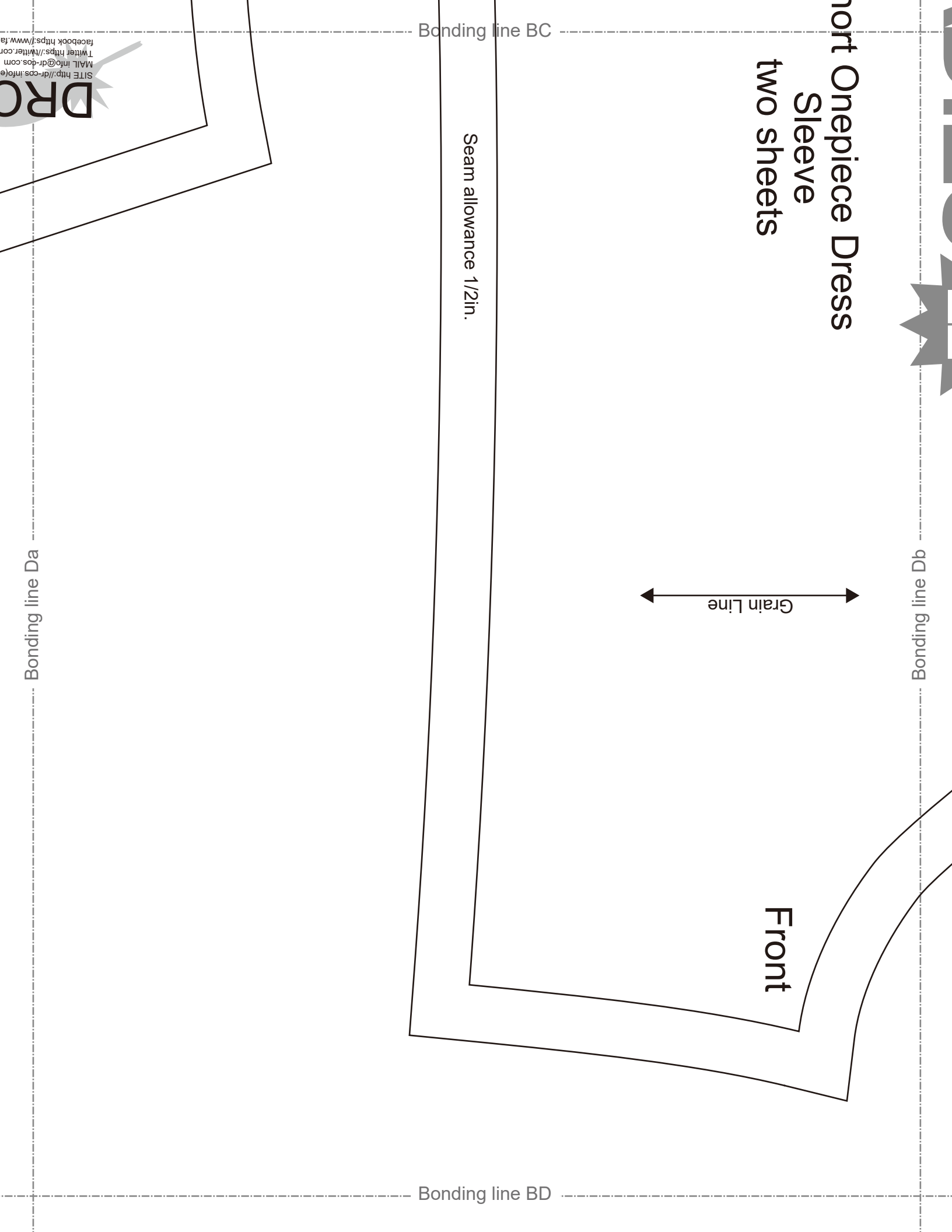
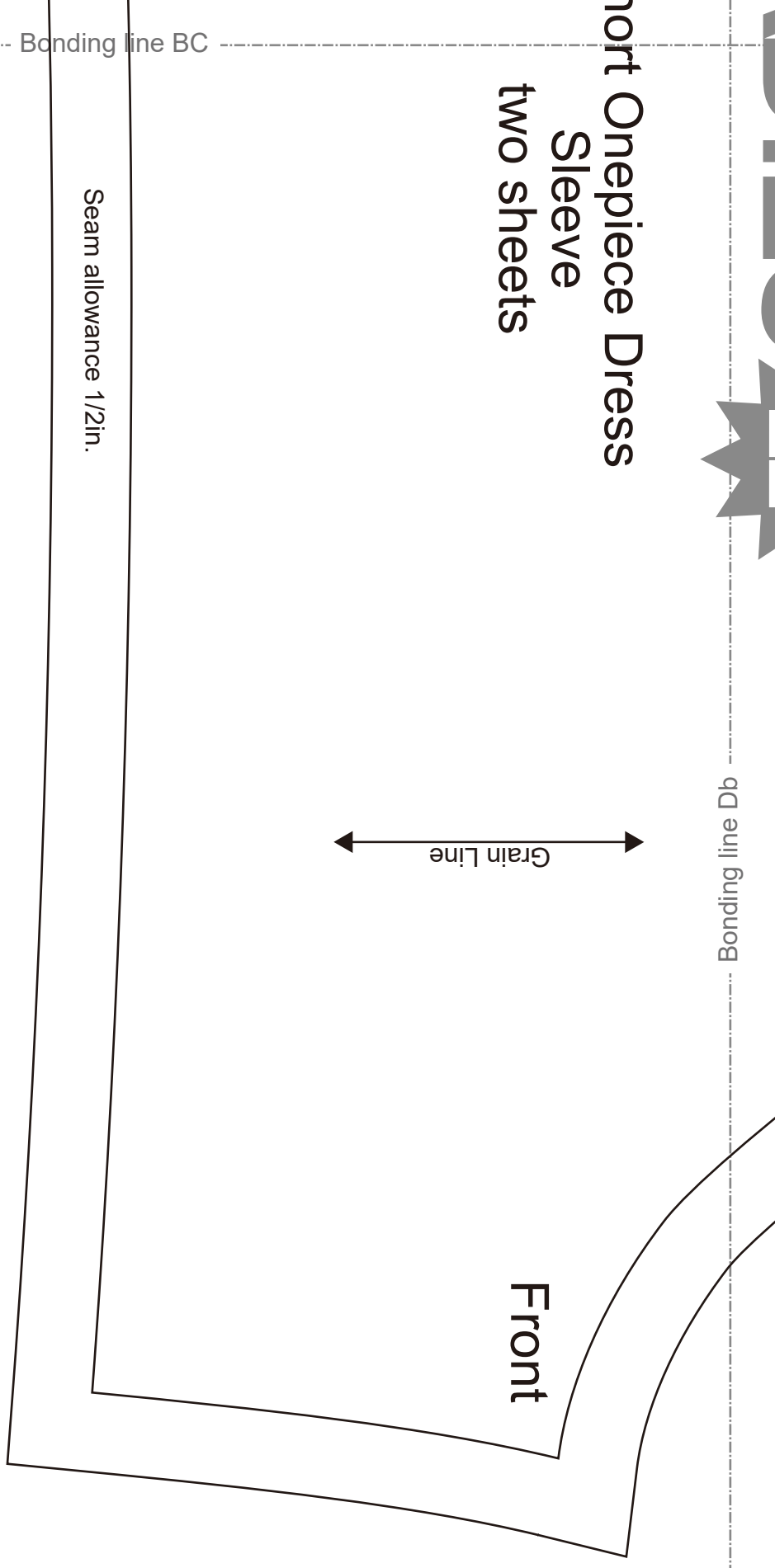

Bonding line Da

Bonding line BC

Bonding line BD

Bonding line Db

Seam allowance 1/2in.

Grain Line

Front

DRC

SITE <http://dr-cos.info>  
EMAIL [info@dr-cos.com](mailto:info@dr-cos.com)  
Twitter <https://twitter.com/dr-cos>  
facebook <https://www.facebook.com/dr-cos>



Bonding line Ab

2 in.

Bonding line Ac

ess

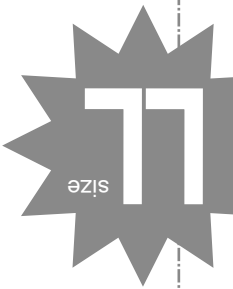

Bonding line CA

Bonding line CA

Bonding line Bb

Bonding line Bc

Bonding line CB

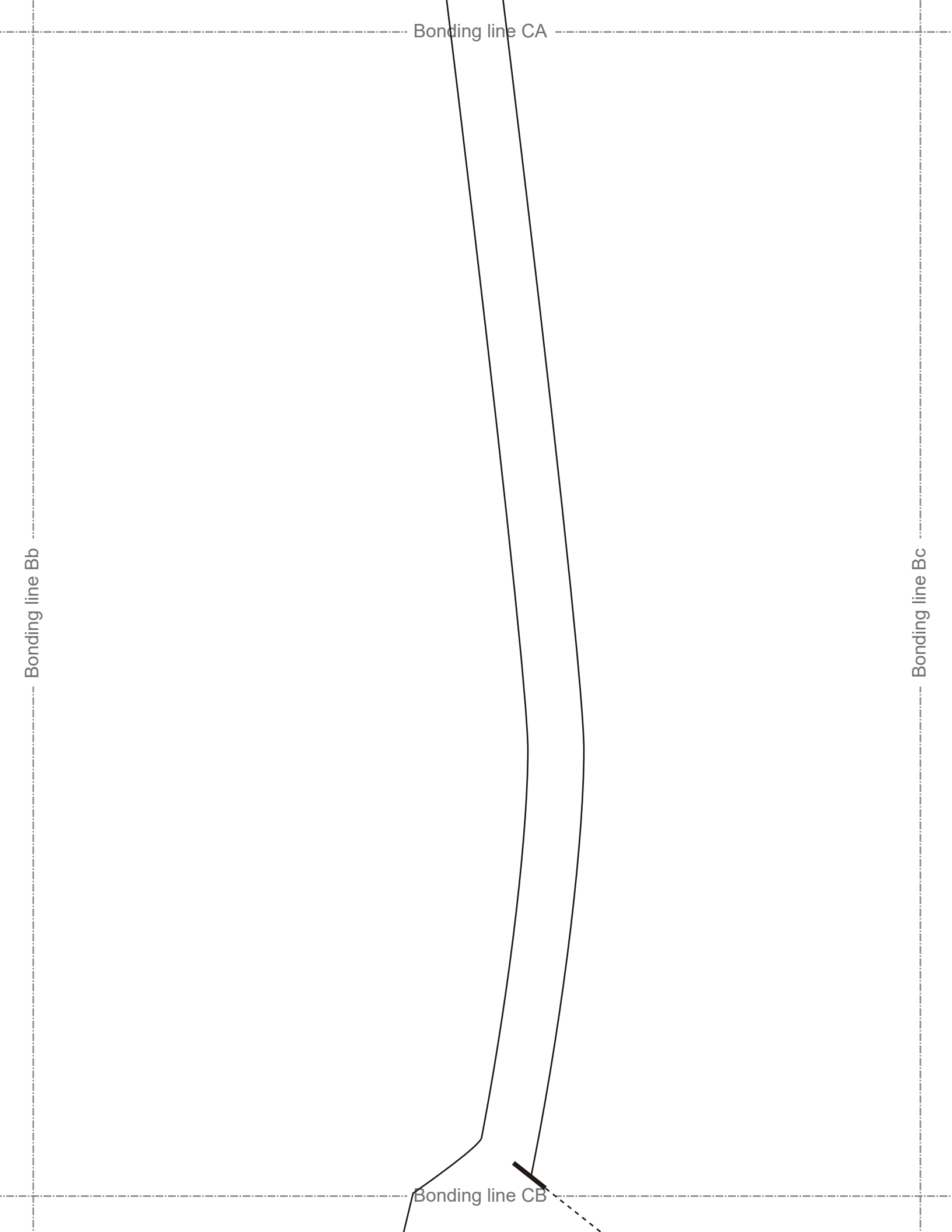

LAD

Bonding line Cb

Bonding line CB

Dart

Bonding line Cc

Bonding line CC

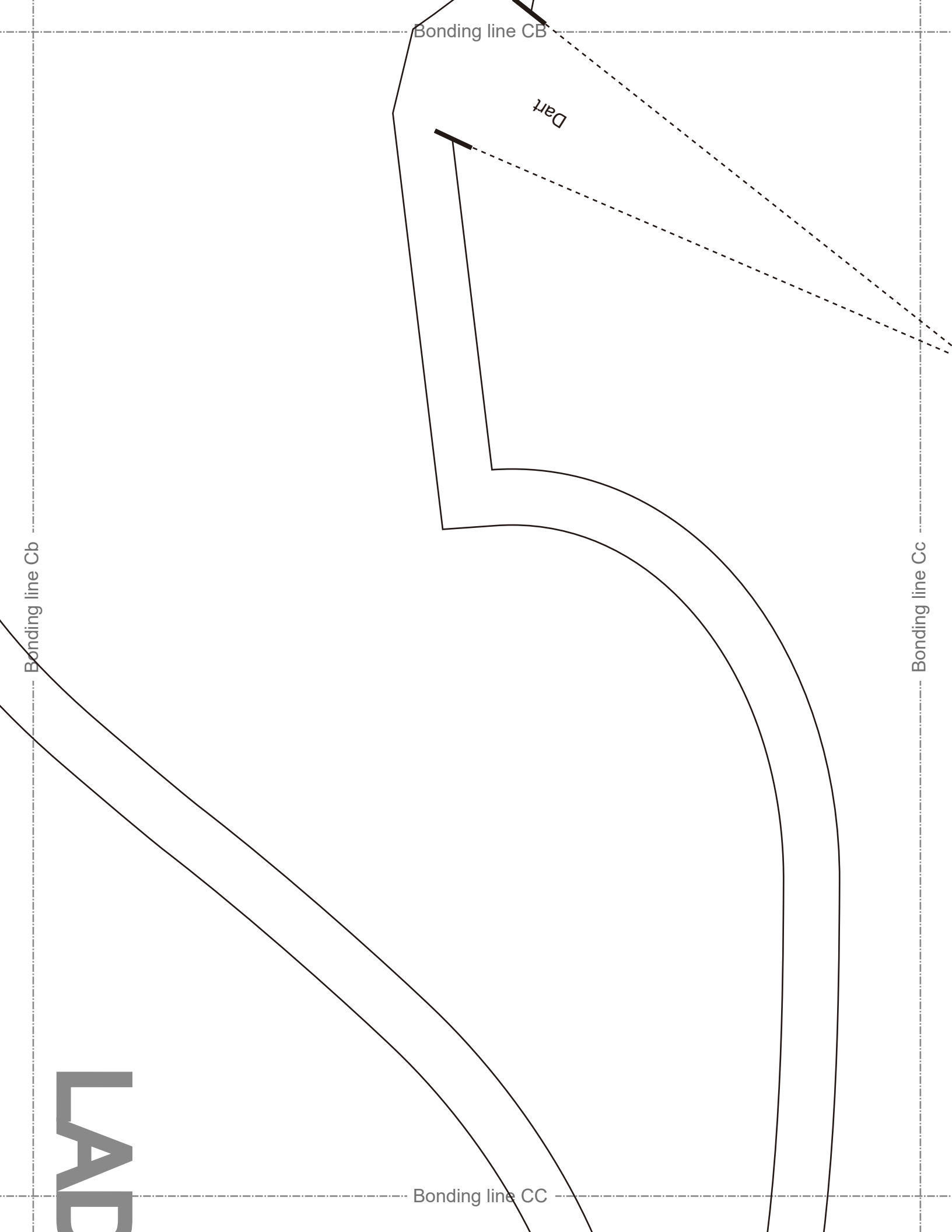

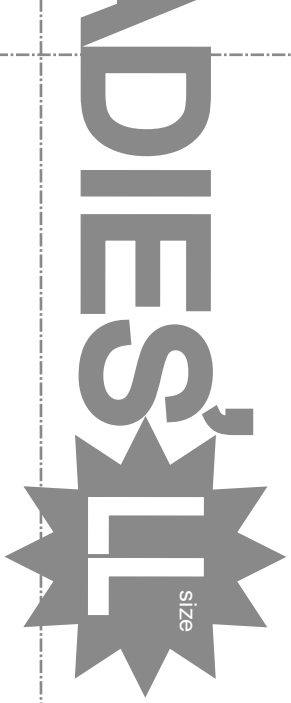

Bonding line Db

Bonding line CC

**DRCOS**  
SITE <http://dr-cos.info/en> | <http://dr-cos.com/tp>  
MAIL [info@dr-cos.com](mailto:info@dr-cos.com)  
Twitter [https://twitter.com/dr-cos\\_com](https://twitter.com/dr-cos_com)  
facebook <https://www.facebook.com/drcoscom>

<http://dr-cos.com/tp>  
[info@dr-cos.com](mailto:info@dr-cos.com)  
[https://twitter.com/dr-cos\\_com](https://twitter.com/dr-cos_com)  
<https://www.facebook.com/drcoscom>

**DRCOS**

Bonding line Dc

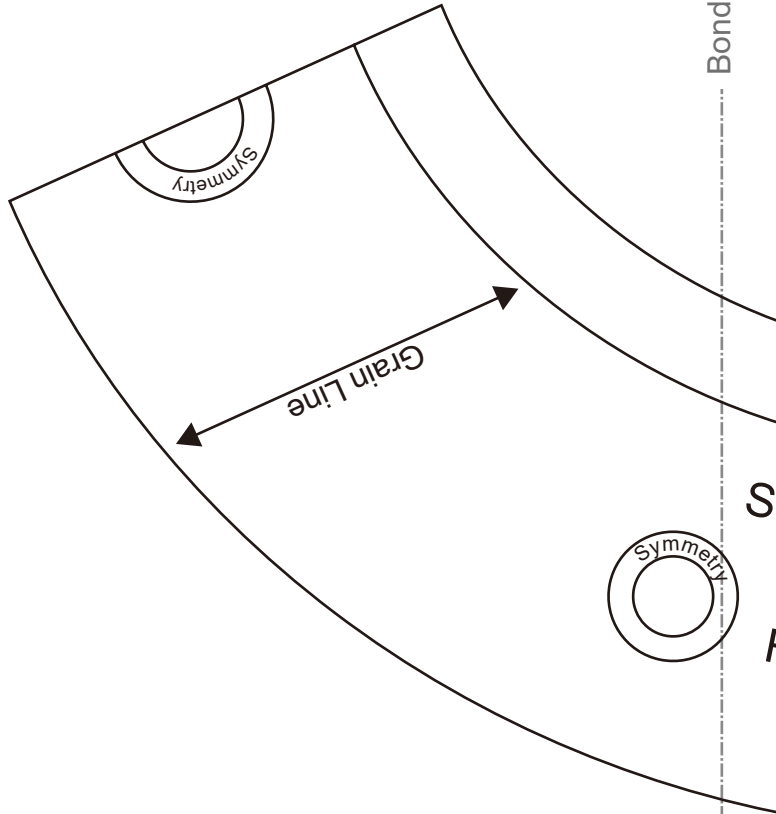

Bonding line CD

# LADIES

Short One-piece Dress  
Front Body  
one sheets



Seam allowance 1/2in.

Bonding line Ac

Bonding line DA

Bonding line Ad

Bonding line DA

Bonding line Bc



Bonding line DB

Bonding line Bd



Bonding line DB

Bonding line Cc

Bonding line Cd

Bonding line DC

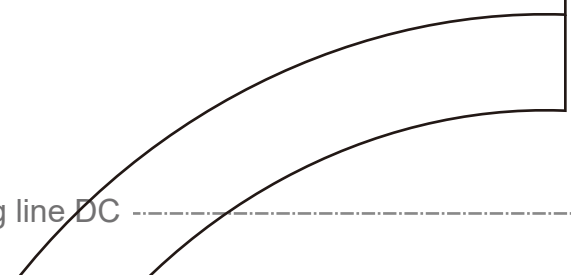
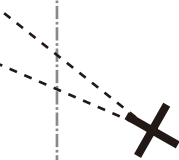

Bonding line DC

**DRCO**  
SITE <http://dr-cos.info/en> <http://dr-cos.com>  
MAIL [info@dr-cos.com](mailto:info@dr-cos.com)  
Twitter <https://twitter.com/dr-cos>  
facebook <https://www.facebook.com/dr-cos>

Bonding line Dc

Seam allowance 1/2in.

**DRCOS**  
SITE <http://dr-cos.info/en> <http://dr-cos.com>  
MAIL [info@dr-cos.com](mailto:info@dr-cos.com)  
Twitter <https://twitter.com/dr-cos>  
facebook <https://www.facebook.com/dr-cos.com>

Bonding line Dd

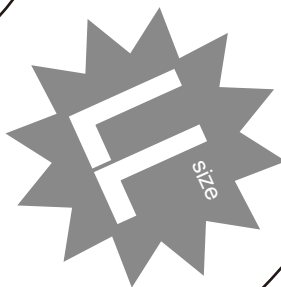

**Short Onepiece Dress Facing**  
One sheets  
**Fusible interlining**  
One sheets



Bonding line DD