

Bonding line Aa

Bonding line AA



Seam allowance 1/2in.

Bonding line AA

Bonding line Ba

Bonding lines

Bonding lines

Open without sewing a place to thread the elastic on one side

Bonding line AB

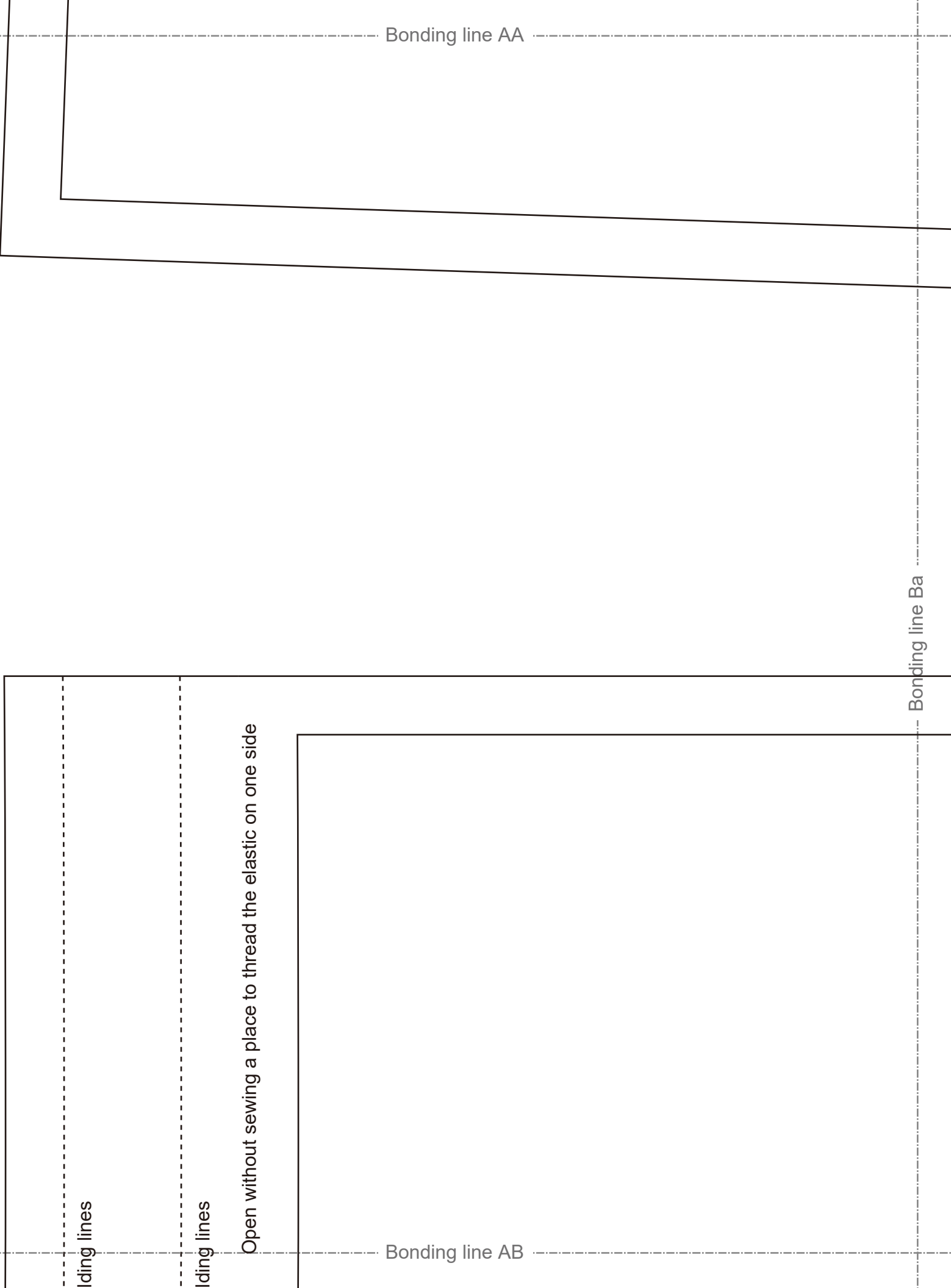

Folding line

Folding line

Open

Bonding line AB

Bonding line Ca

Bonding line AC

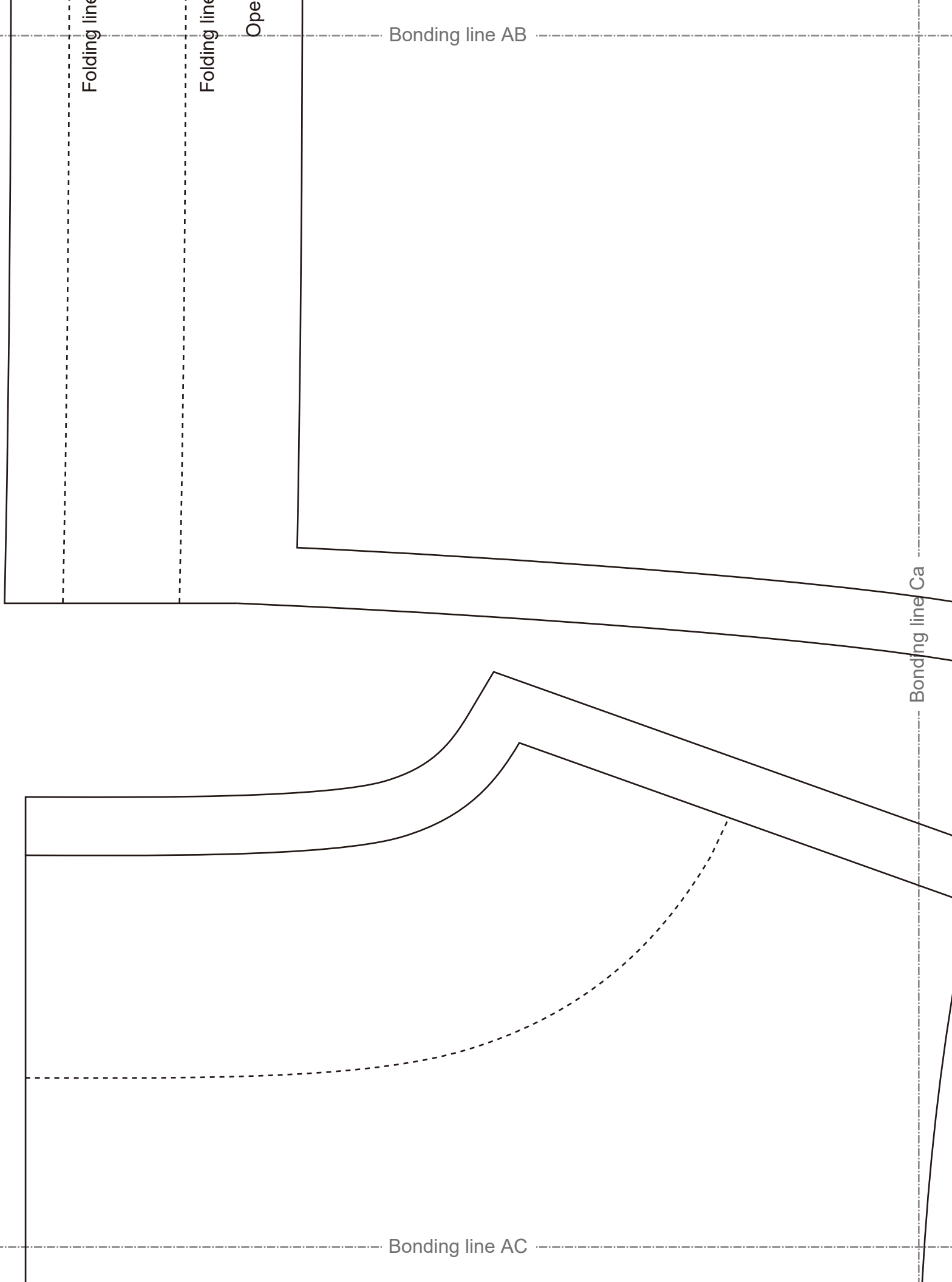

Bonding line AC

Bonding line Da

LADIES'  size S

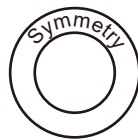

Santa Claus
Back Body
one sheets

Bonding line AD

Bonding line AD

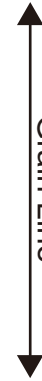

Grain Line

Bonding line Ea

Bonding line AE

allowance 1/2in.

Bonding line AE

Seam allowance 1/2in.

LADIES'

Bonding line Fa

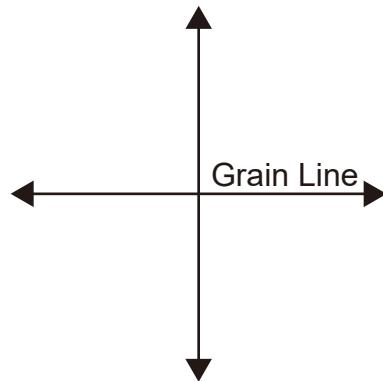

Bonding line AF

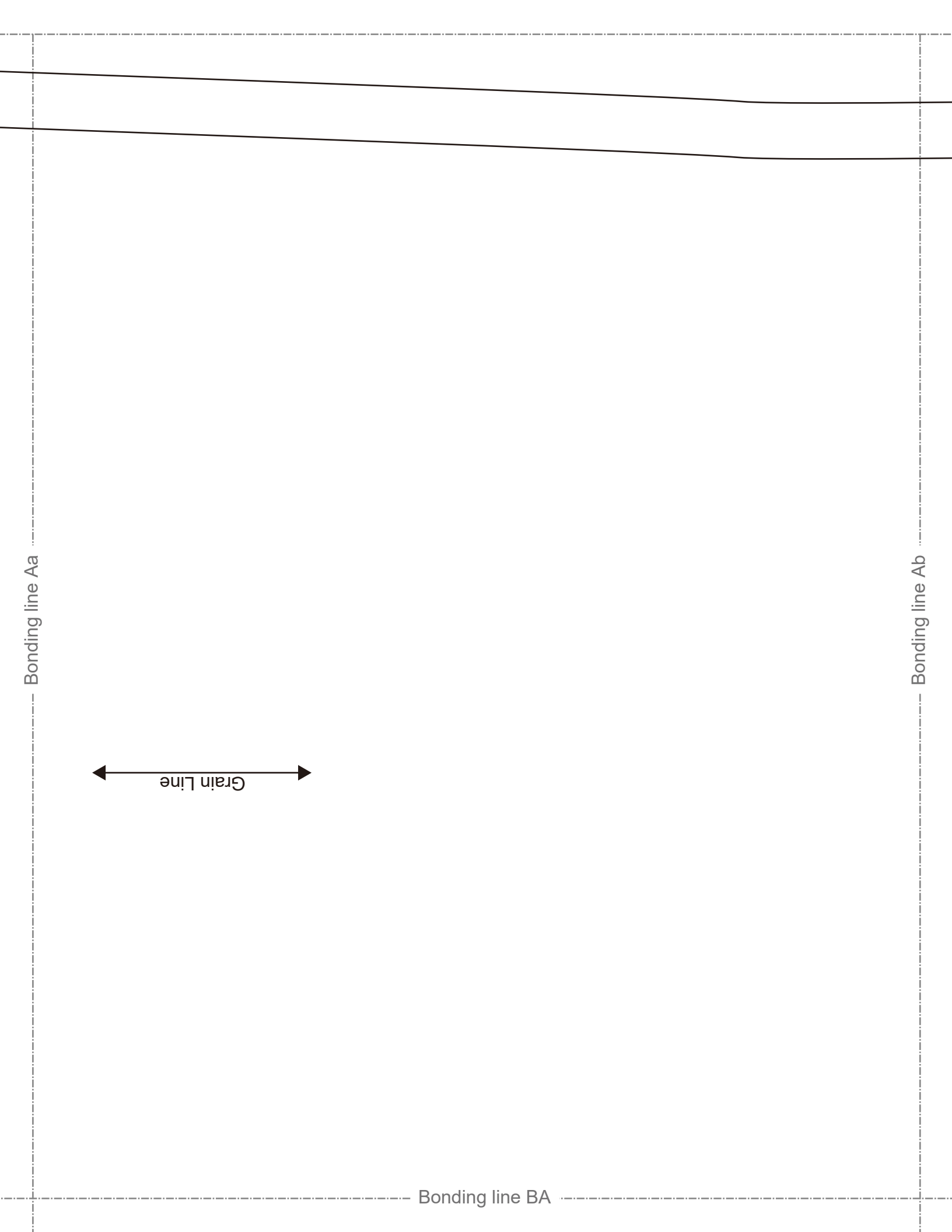

Bonding line Aa

Bonding line Ab

Bonding line BA

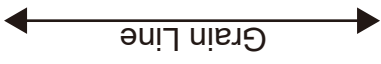

Grain Line

Bonding line BA

Bonding line Ba

Bonding line Bb

Bonding line BB

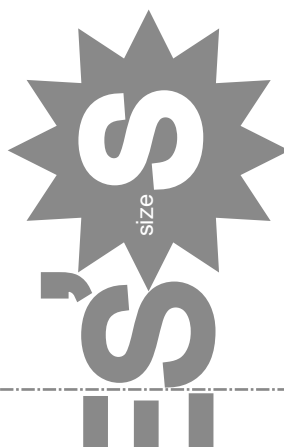

Claus
ont Body
heets

Bonding line BB

LADIES

Santa Clara
Pants Front E
two sheet

Bonding line Ca

Bonding line Cb

Seam allowance 1/2in.

DRCOS
 SITE <http://dr-cos.info/en> <http://dr-cos.com/jp>
 MAIL info@dr-cos.com
 TWITTER https://twitter.com/dr-cos_com
 FACEBOOK <https://www.facebook.com/drcoscom>

Bonding line BC

Bonding line BC

Bonding line Da

Bonding line Db

Grain Line



anta Claus
nt Body(left)
ne sheets



Bonding line BD



Bonding line BD

Bonding line Ea

Bonding line Eb

DRCOS

SITE <http://dr-cos.info/en> <http://dr-cos.com/jp>
MAIL info@dr-cos.com
Twitter https://twitter.com/drcos_com
facebook <https://www.facebook.com/drcoscom>

Bonding line BE

Bonding line BE

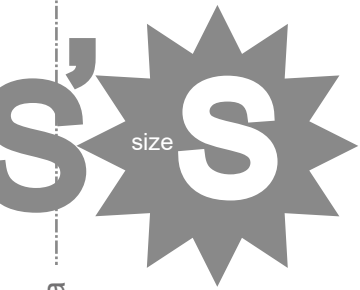

Bonding line Fa

Bonding line Fb

Folding lines

Santa Claus
Back Hem
one sheets

Seam allowance 1/2in.

Bonding line BF

LADIES'S S

Santa Claus
Pants Back Body
two sheets

Bonding line Ab

Bonding line Ac

Bonding line CA

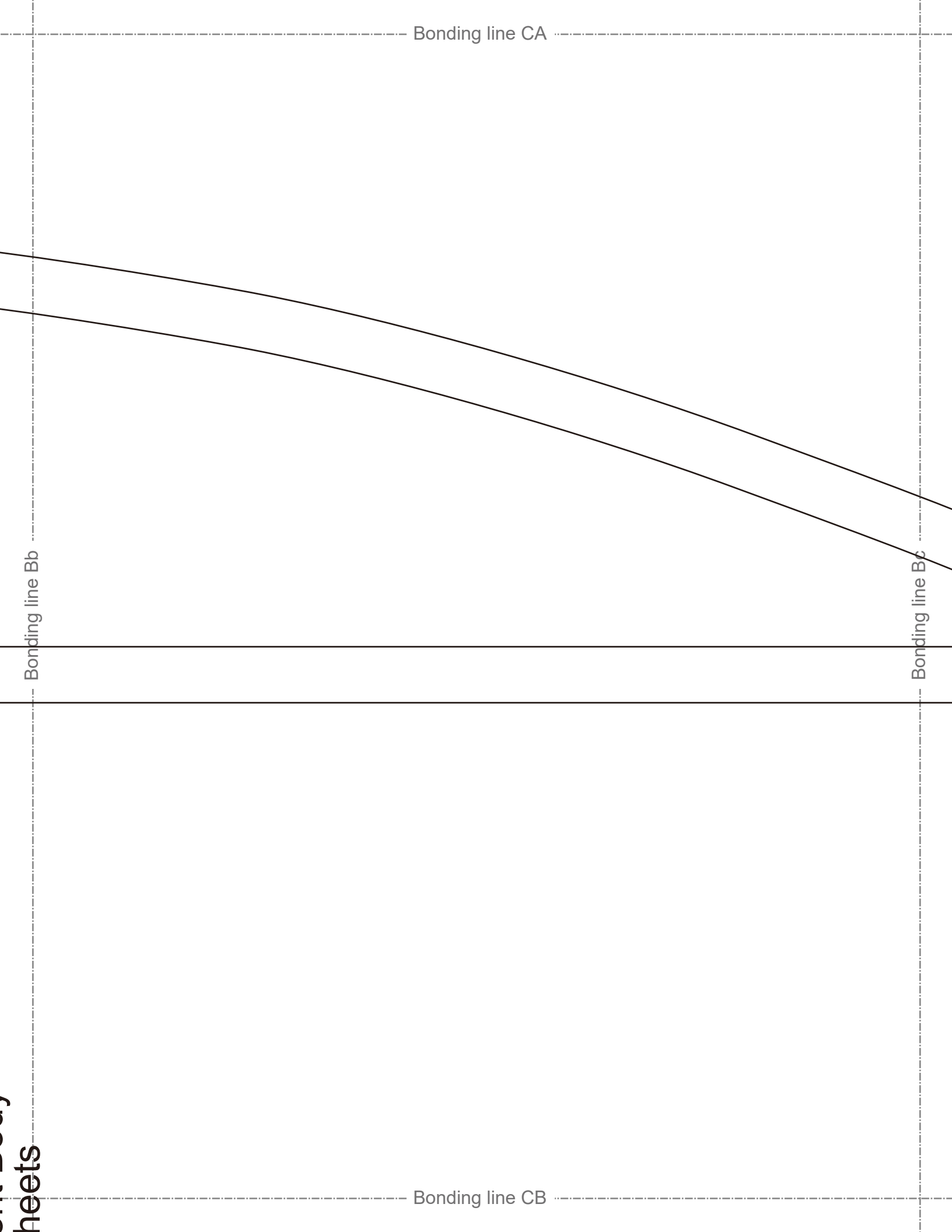

two sheet

Bonding line CB

Bonding line Cb

Bonding line Cc

Bonding line CC

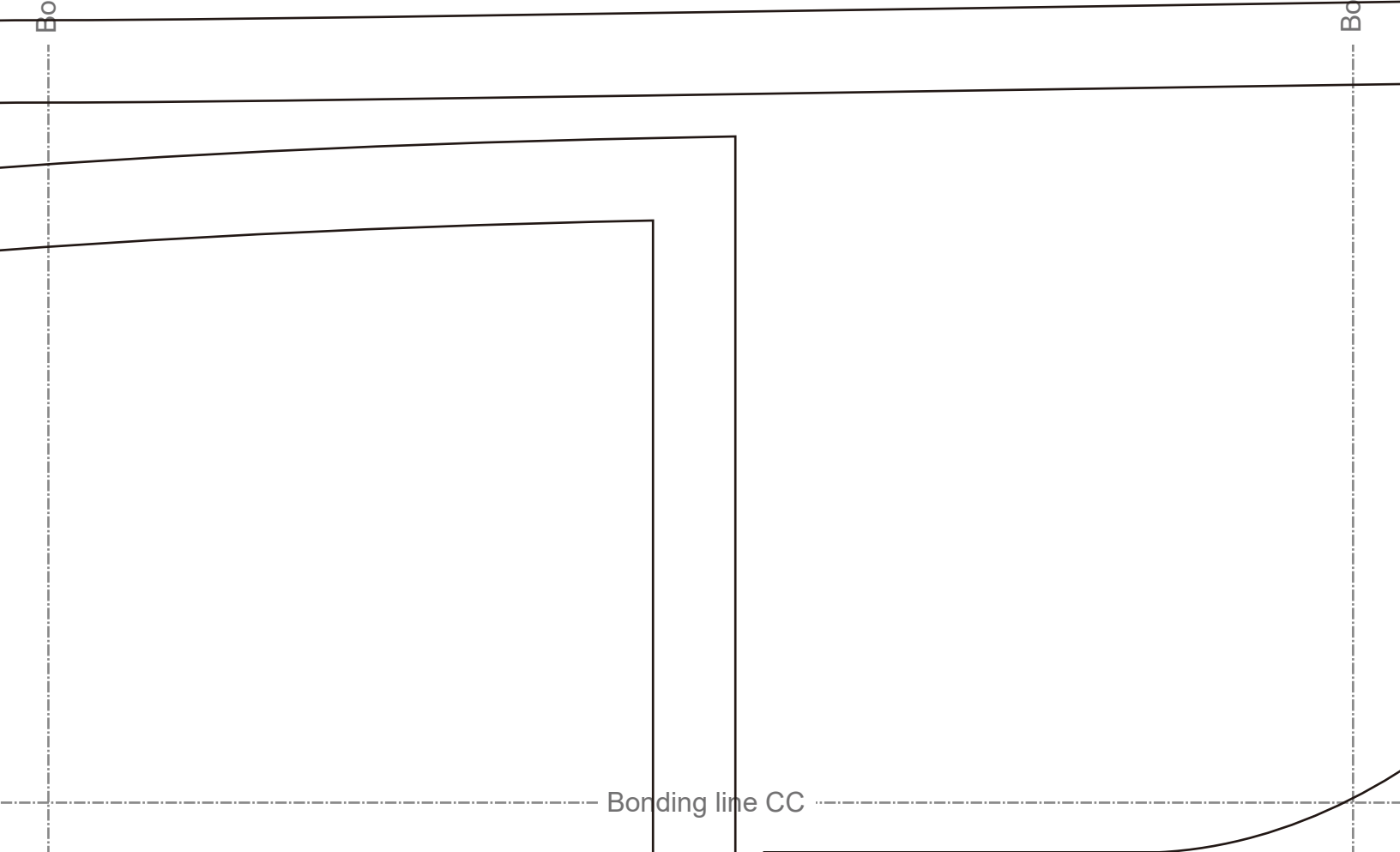

LADIE

Santa
Front B
one s

Bonding line Db

Bonding line CC

Bonding line CD

Bonding line Dc

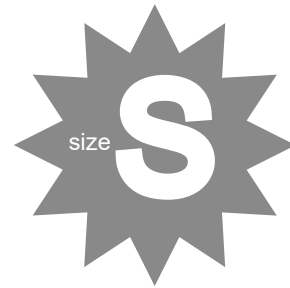

sheets
sheets

1100

Bonding line Eb

Bonding line CD

Bonding line CE

Bonding line Ec

Santa Claus
Facing(right front) one sheet
Fusible interlining one sheet



Bonding line CE

Seam allowance 1/2in.

White Boa Fabric

Bonding line Fb

Bonding line Fc

US
n
S



Bonding line CF

Bonding line Ac

Bonding line Ad

Bonding line DA

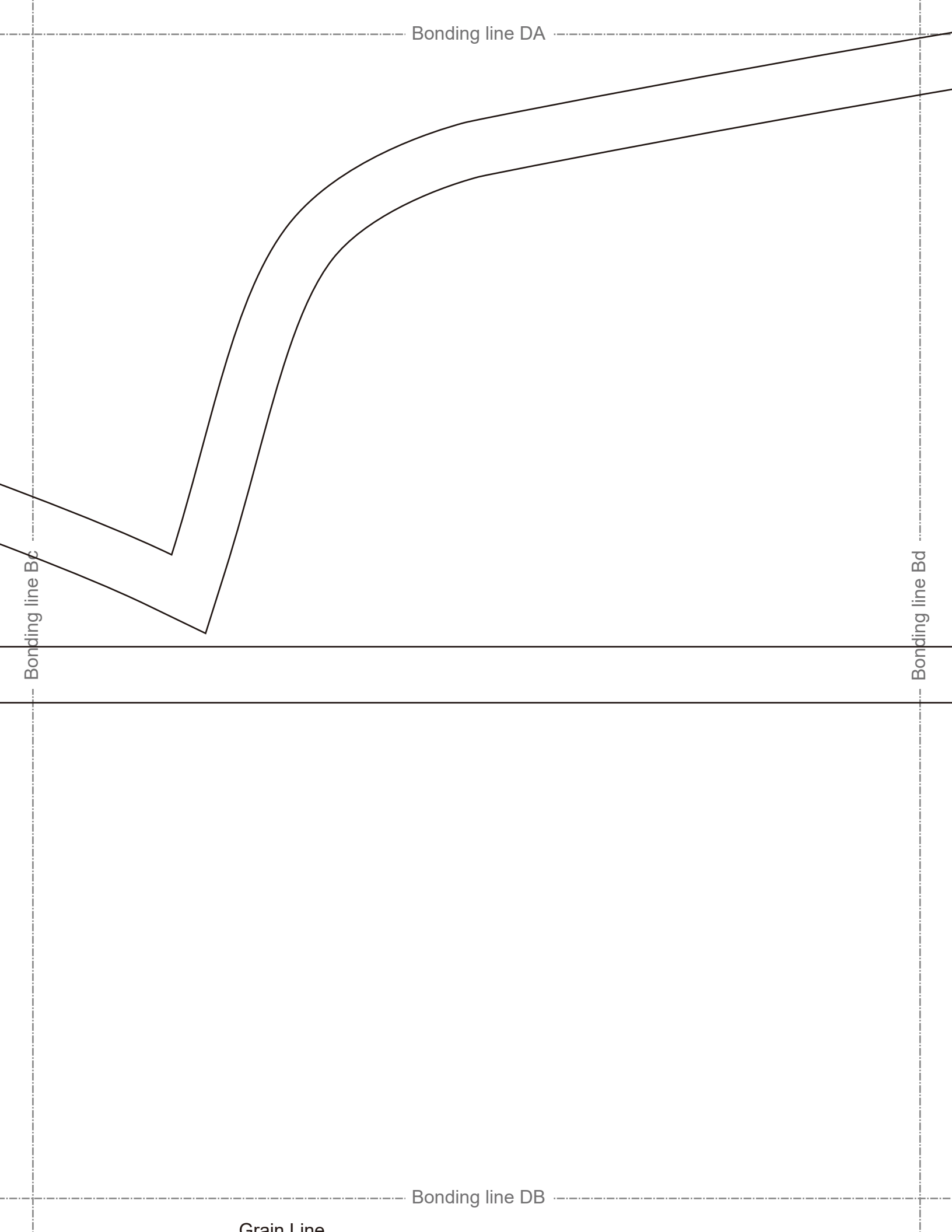

Bonding line DB

Grain Line

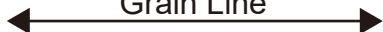

Bonding line Cc

Bonding line Cd

DRCOS

SITE: <http://drcos-intro.com>
MAIL: info@drcos.com
TWITTER: <https://twitter.com/drcos>
FACEBOOK: <https://www.facebook.com/drcos.com>

Bonding line DC

Bonding line DC

Bonding line Dc

Bonding line Dd

LADIE

Santa Cl
Front Body
one she

Bonding line DD

Bonding line Ec

Bonding line DD

Bonding Line
Grain Line

DRCOS

SITE [http://dr-cos.info\(en\)](http://dr-cos.info(en)) [http://dr-cos.com\(jp\)](http://dr-cos.com(jp))
MAIL info@dr-cos.com
Twitter [@drcos_com](https://twitter.com/@drcos_com)
facebook <https://www.facebook.com/drcoscom>

Bonding line DE

Bonding line DE

S

LADIES'  size S

Bonding line Fc

Bonding line Fd

Folding lines

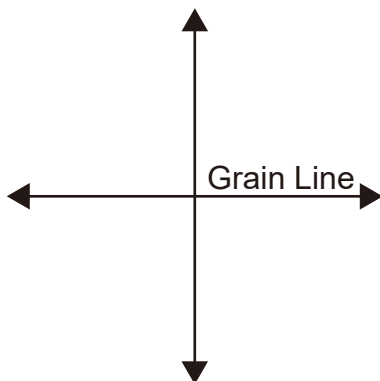

San
front H
one

Seam allowance 1/2

Bonding line DF

Bonding line Ad

Folding lines

Folding lines

Bonding line EA

Bonding line Ae

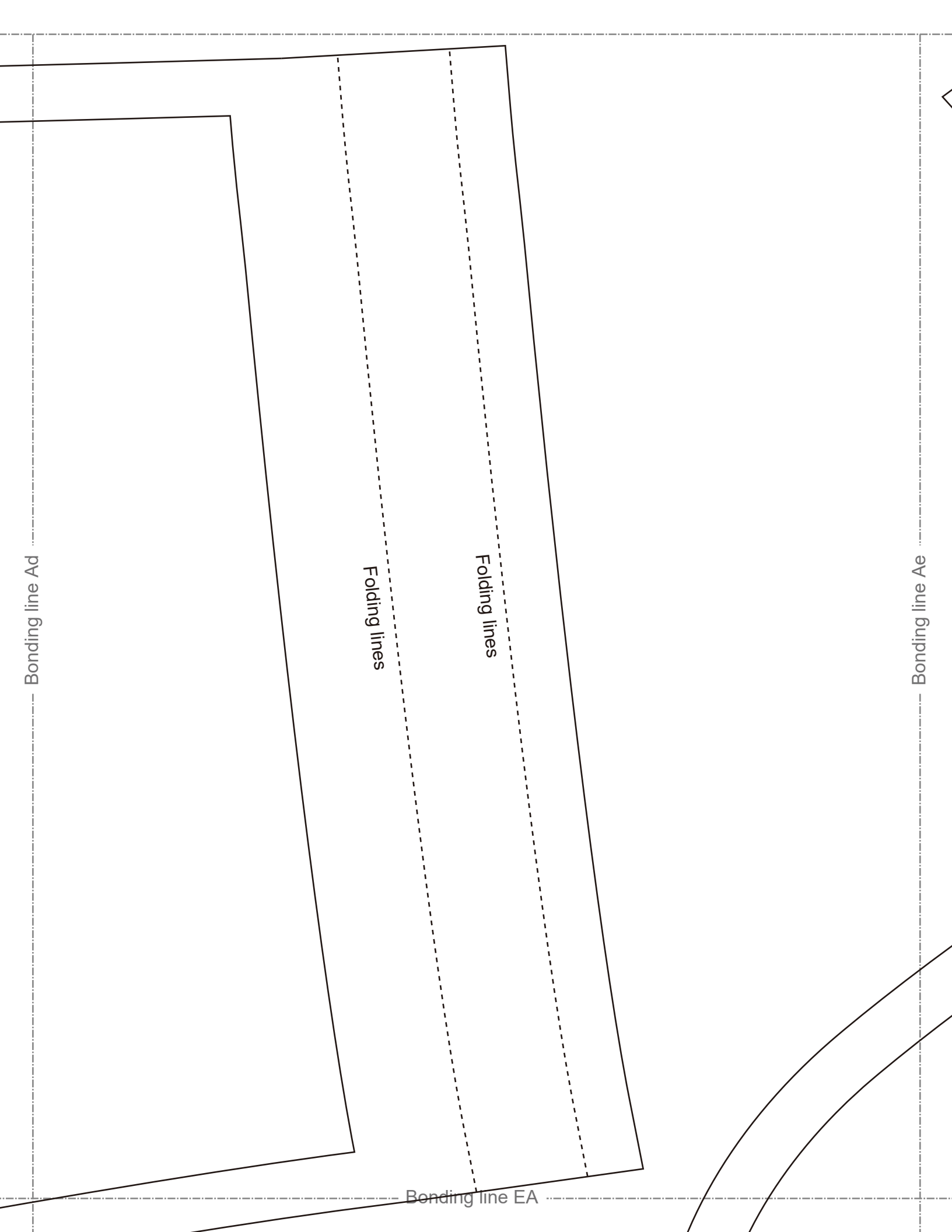

Bonding line Bd

Bonding line EA

Bonding line Be

Bonding line EB

DRCOS

SITE <http://dr-cos.info/en> <http://dr-cos.com/jp>
MAIL info@dr-cos.com
Twitter https://twitter.com/dr-cos_com
facebook <https://www.facebook.com/drcoscom>

DRCOS

SITE <http://dr-cos.info/en> <http://dr-cos.com/jp>
MAIL info@dr-cos.com
Twitter https://twitter.com/dr-cos_com
facebook <https://www.facebook.com/drcoscom>

ance 1/2in.

Sheets

ur

Bonding line Cd

Bonding line EB

Seam allowance 1/2

Grain Line

Bonding line Ce

Bonding line EC

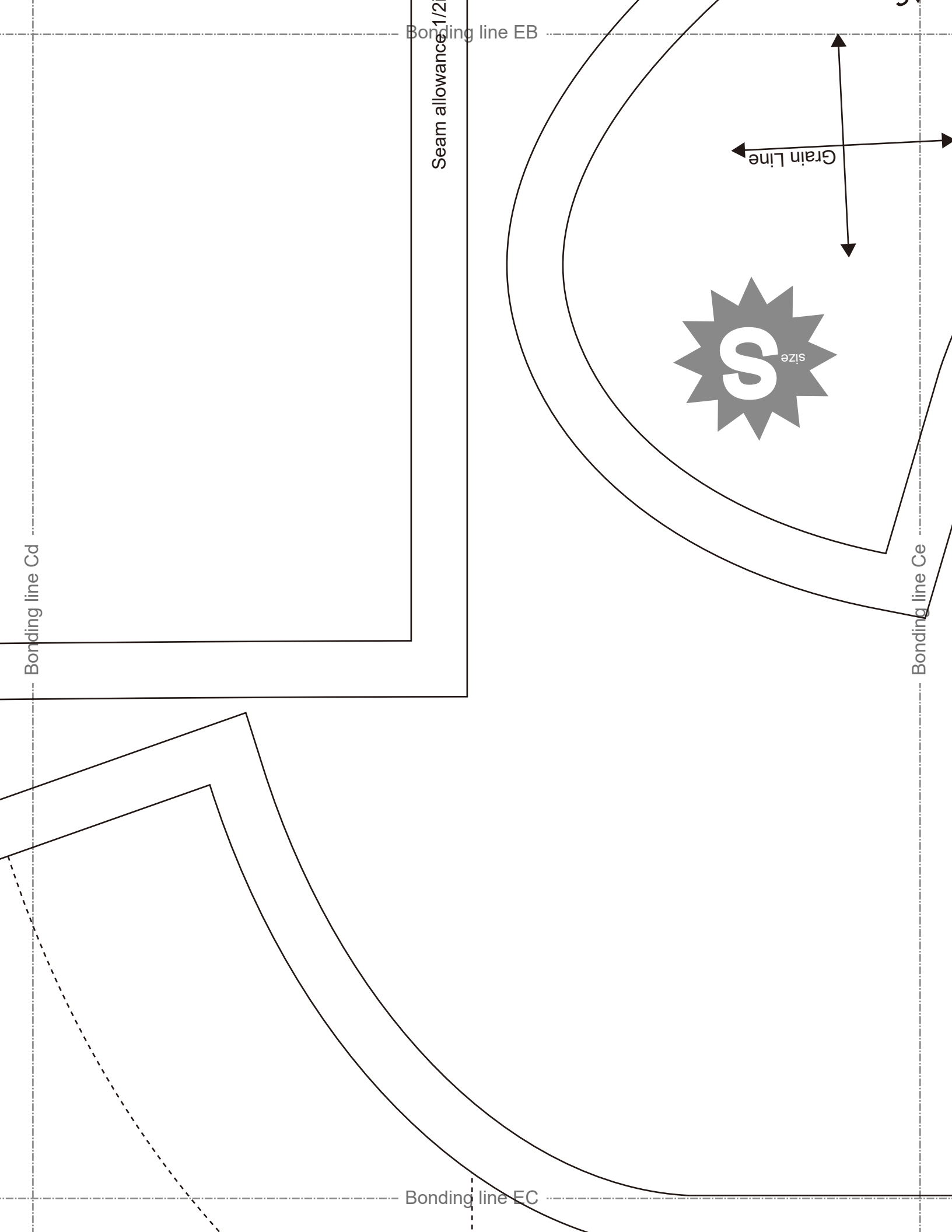

Bonding line EC

Snap Button



Collar Position

Baste

Bonding line Dd

Bonding line De

velcro tape

center line

Bonding line ED

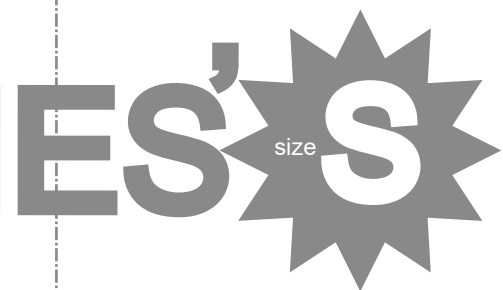

a Claus
Body(right)
sheets

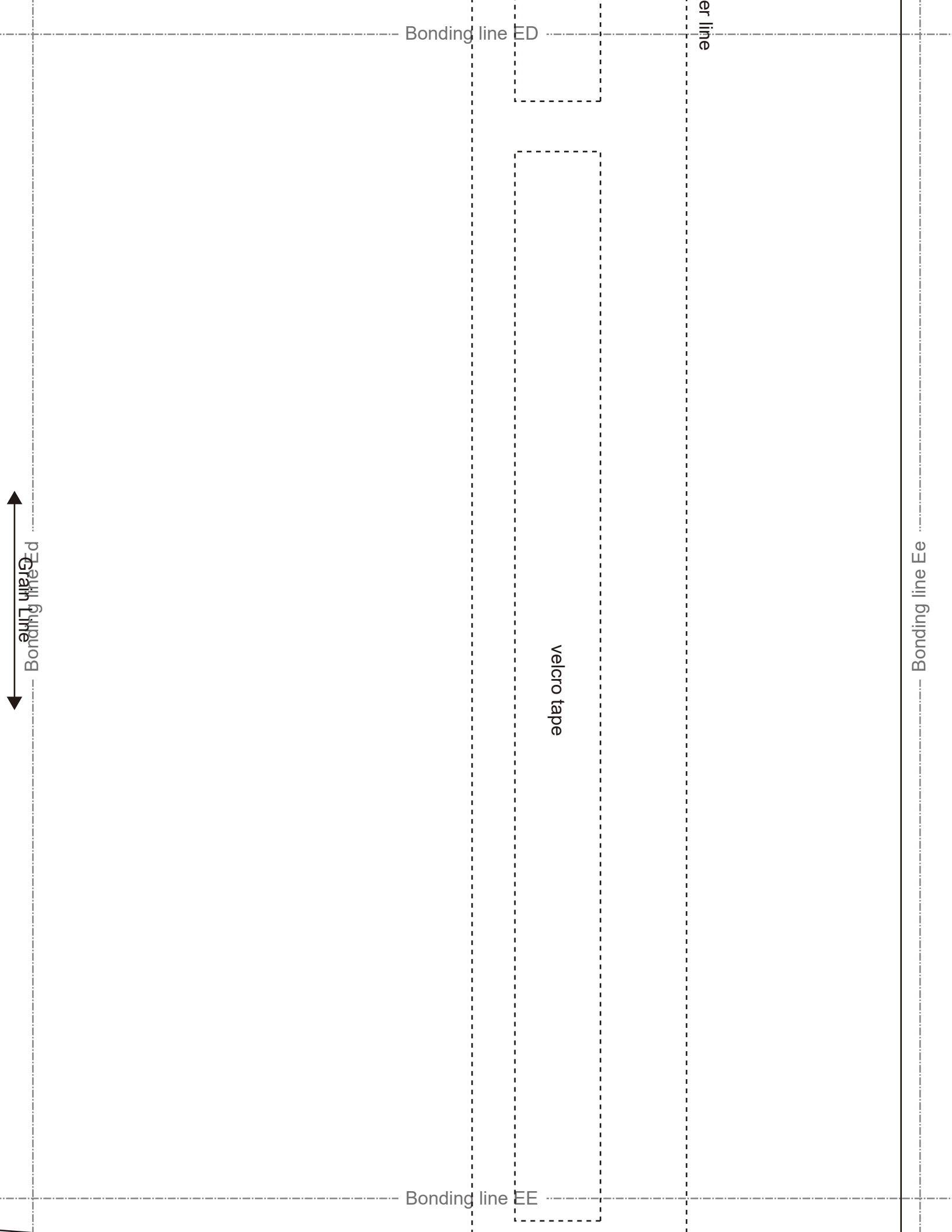

Bonding line EE

Seam allowance 1/2in.

White Boa Fabric

Bonding line Fd

Bonding line Fe

lines

Santa Claus
Front Hem (right)
one sheets



Seam allowance 1/2in.

Bonding line EF

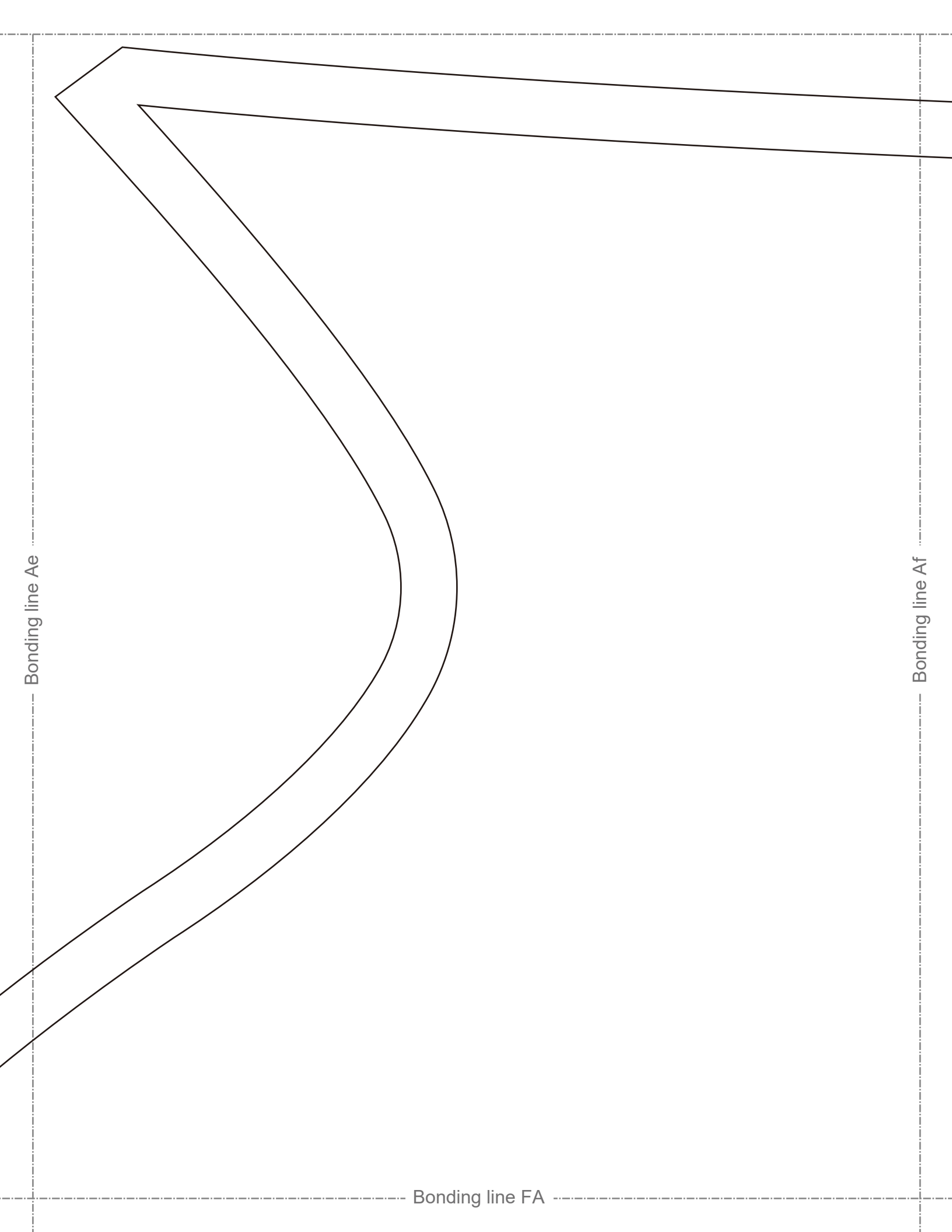

Bonding line FA

Twitter https://twitter.com/@drcos_com
facebook <https://www.facebook.com/drcoscom>

Bonding line Be

Bonding line Bf

Seam allowance 1/2in.

Santa Claus
Collar one sheets
Facing one sheets
Fusible interlining one sheets



White Boa Fabric

DRCOS
SITE <http://drcos.info/en> <http://drcos.com/jp>
MAIL info@drcos.com
Twitter https://twitter.com/@drcos_com
facebook <https://www.facebook.com/drcoscom>



Bonding line FB

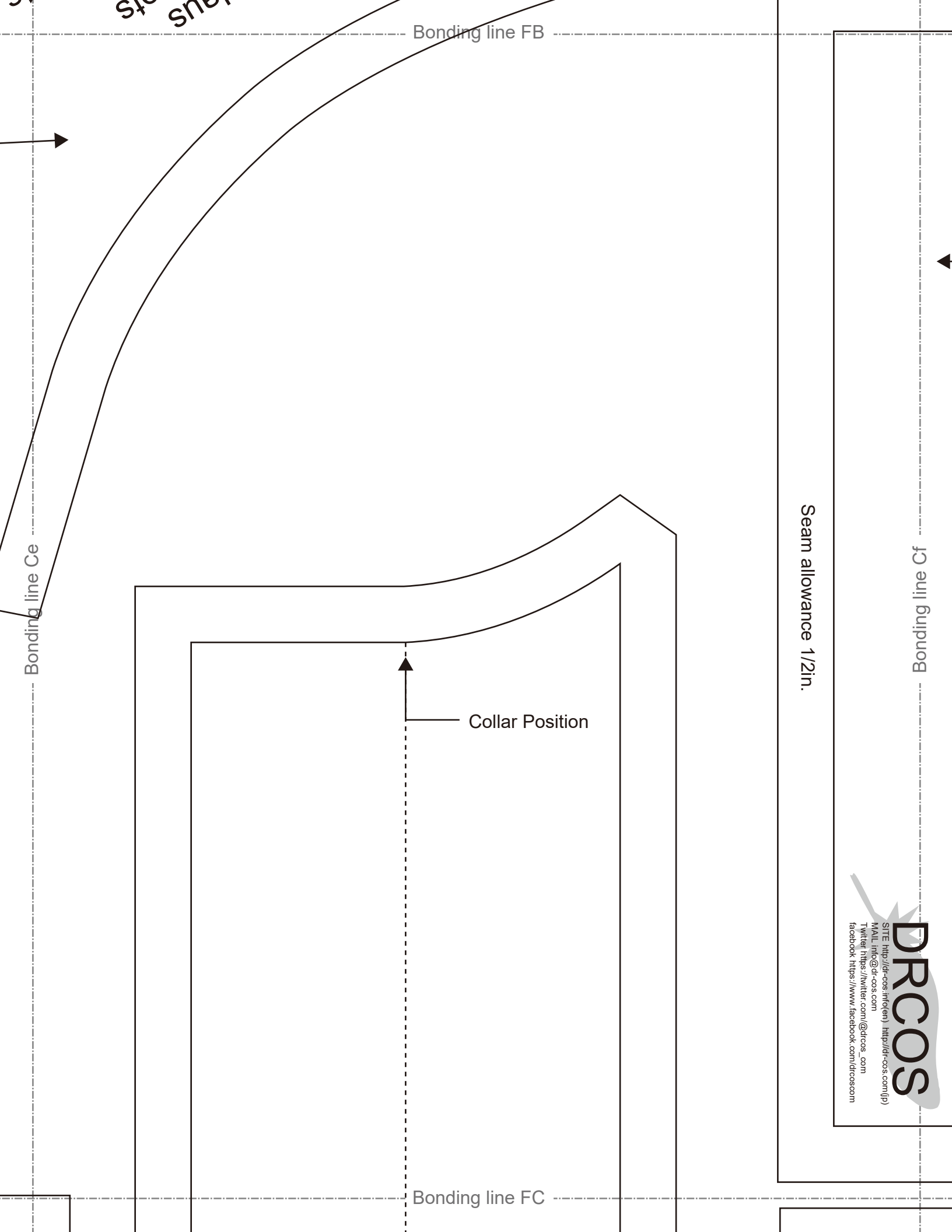

Sto
sho

Bonding line FB

Bonding line Ce

Collar Position

Bonding line FC

Seam allowance 1/2in.

Bonding line Cf

DRCOS
SITE <http://dr-cos.info/en> <http://dr-cos.com/pt>
MAIL info@dr-cos.com
Twitter [@drcos_com](https://twitter.com/@drcos_com)
facebook <https://www.facebook.com/drcoscom>

Bonding line De

Bonding line FC

Santa Claus
Placket Front(left) one sheets



center line

White Boa Fabric

Bonding line FD

Seam allow

Bonding line Df

Bonding line Ee

Bonding line FD

Seam allowance 1/2in.

Bonding line Ef

DRCOS
 SITE <http://dr-cos.info/en> <http://dr-cos.com/jp>
 MAIL info@dr-cos.com
 Twitter <https://twitter.com/@drcos.com>
 facebook <https://www.facebook.com/drcos.com/>

Seam allowance 1/2in.

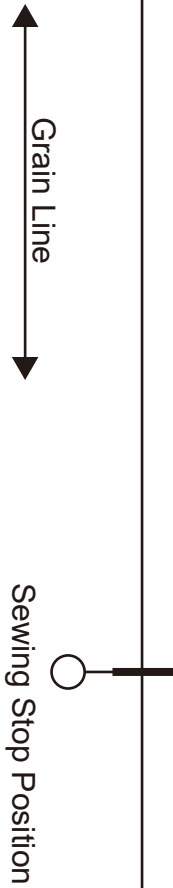

Bonding line FE

DRCOS
 SITE <http://dr-cos.info/en> <http://dr-cos.com/jp>
 MAIL info@dr-cos.com
 Twitter <https://twitter.com/@drcos.com>
 facebook <https://www.facebook.com/drcos.com/>

Bonding line FE

SOCS
http://dr-cos.com/ (en)
@dr-cos .com
dr-cos .com
w.facebook.com/dr-coscom

LADIES'  S
size

Bonding line Fe

Bonding line Ff

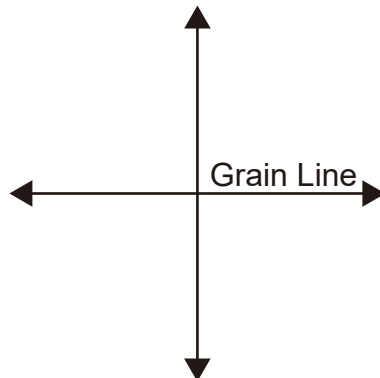

Santa Claus
Sleeve Cuffs
two sheets

Seam allowance 1/2in.

Bonding line FF

Bonding line Af

LADIES'S  **S**
size

Santa Claus
Sleeve
two sheets

Bonding line GA

Bonding line Ag

Bonding line GA

Bonding line Bf

Bonding line Bg

Bonding line GB

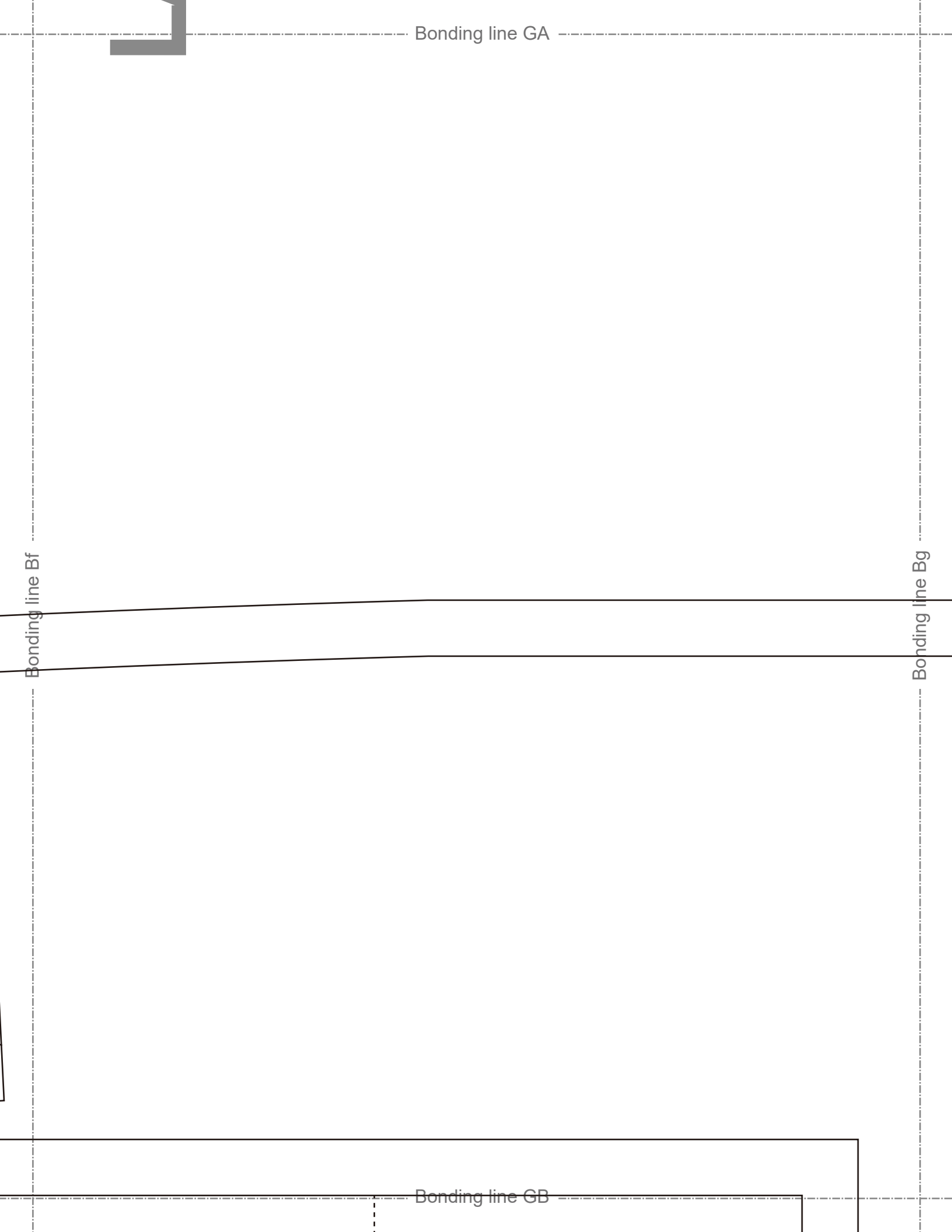

Bonding line GB



White Boa Fabric

Folding lines

Santa Claus
front Hem (left)
one sheets

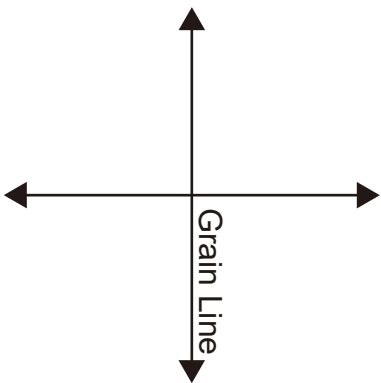

Bonding line Cf

Bonding line Cg

Bonding line GC

DRCOS

Bonding line GC

Bonding line Df

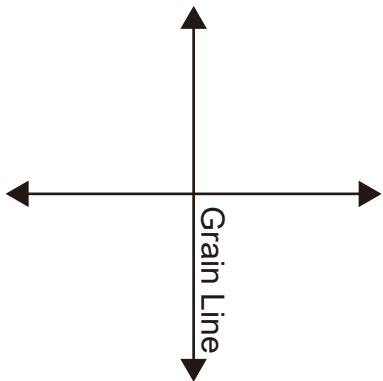

LADIES'S
size
S

Bonding line GD

Bonding line Dg

Bonding line Eg

White Boa Fabric

Bonding line GD

Folding lines

Santa Claus
Pants Hem
two sheets

Bonding line GE

Bonding line Ef

Bonding line GE

DRCOS

SITE <http://dr-cos.info/en> <http://dr-cos.com/jp>
MAIL info@dr-cos.com
Twitter https://twitter.com/@drcos_com
facebook <https://www.facebook.com/drcoscom>

Bonding line Ff

Bonding line Fg

White Boa Fabric

S
S
S

2in.

Bonding line GF

Bonding line Ag

Bonding line Ah



Seam allowance 1/2in.

Bonding line HA

Bonding line HA

Bonding line Bg

Bonding line Bh

Bonding line HB

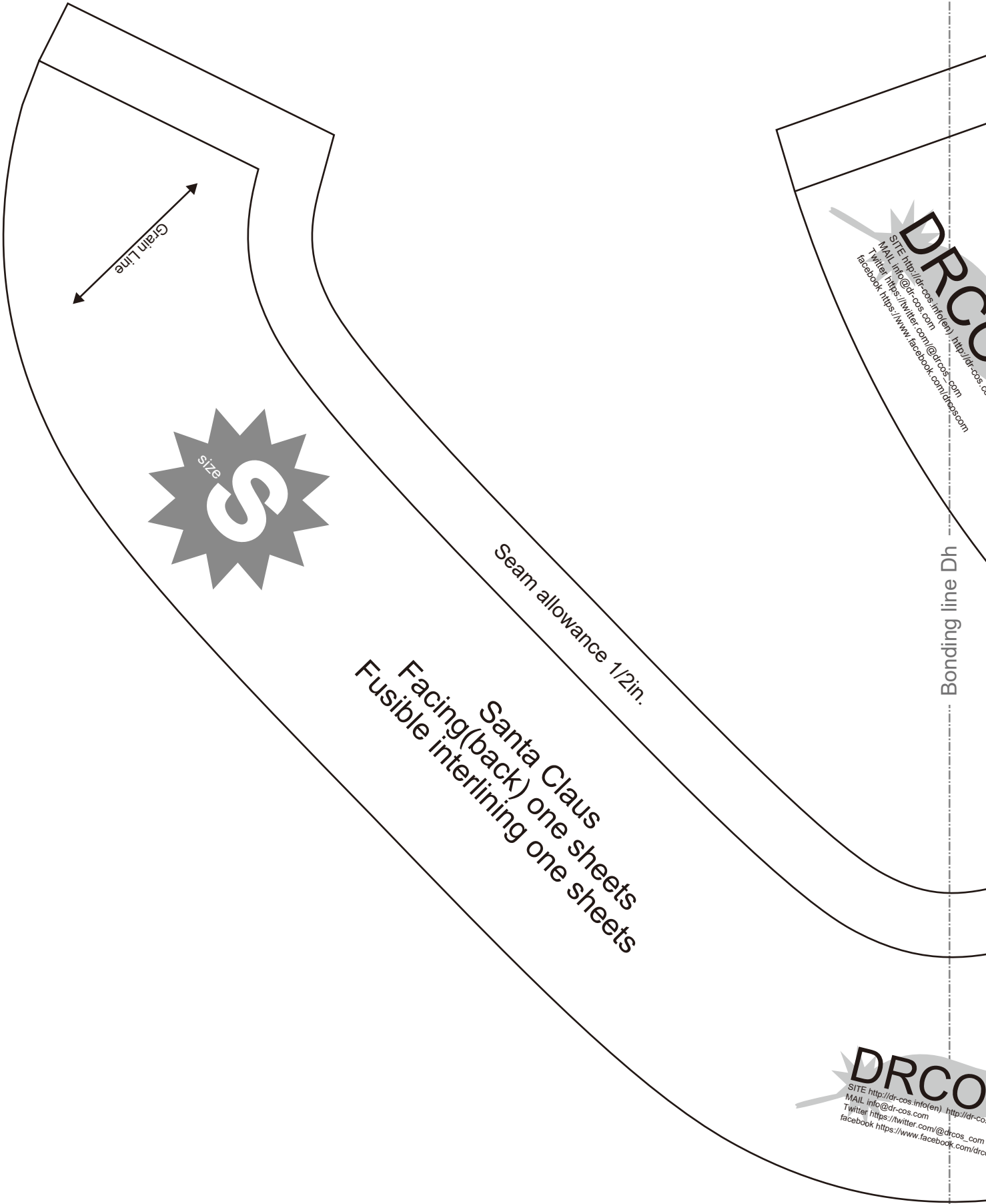

DRCO
 SITE [http://dr-cos.info\(en\)](http://dr-cos.info(en)) <http://dr-co>
 MAIL info@dr-cos.com
 Twitter https://twitter.com/dr-cos_com
 facebook <https://www.facebook.com/drcos>

DRCO
 SITE [http://dr-cos.info\(en\)](http://dr-cos.info(en)) <http://dr-co>
 MAIL info@dr-cos.com
 Twitter https://twitter.com/dr-cos_com
 facebook <https://www.facebook.com/drcos>

Bonding line IC

DRCOS

<http://drcos.info/en>, <http://drcos.com/jp>
[@drcos.com](mailto:drcos.com), <http://drcos.com/jp>
www.facebook.com/drcoscom

Bonding line Dh

Snap Button



DRCOS

<http://drcos.info/en>, <http://drcos.com/jp>
[@drcos.com](mailto:drcos.com), <http://drcos.com/jp>
www.facebook.com/drcoscom

Bonding line ID

Bonding line Eh

Bonding line ID

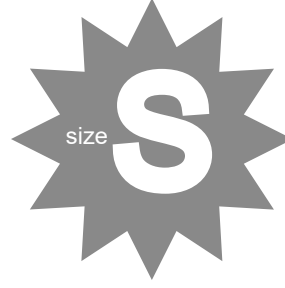

Santa Claus
Facing(left front) one sheets
Fusible interlining one sheets

velcro tape

Bonding line IE

velcro

Bonding line Fh

Bonding line IE

velcro tape



Grain Line



Seam allowance 1/2in.

Bonding line IF