

DRCOS

SITE <https://drcos.info/en> <https://drcos.com/jp>

MAIL info@drcos.com

Twitter https://twitter.com/drcos_com

Pinterest <https://www.pinterest.jp/drcosinfo>

Grain Line

Bonding line Aa

Bonding line AA

Bonding line AA

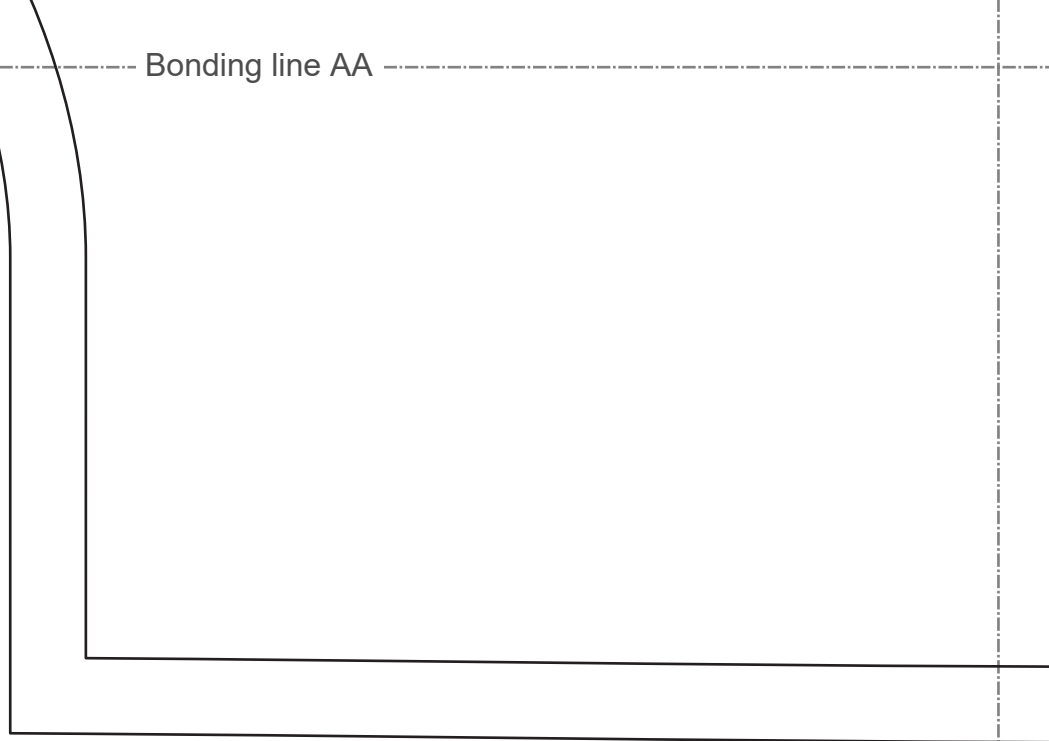

Button position

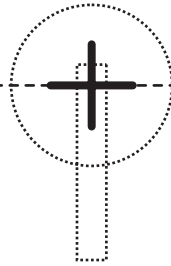

Bonding line Ba

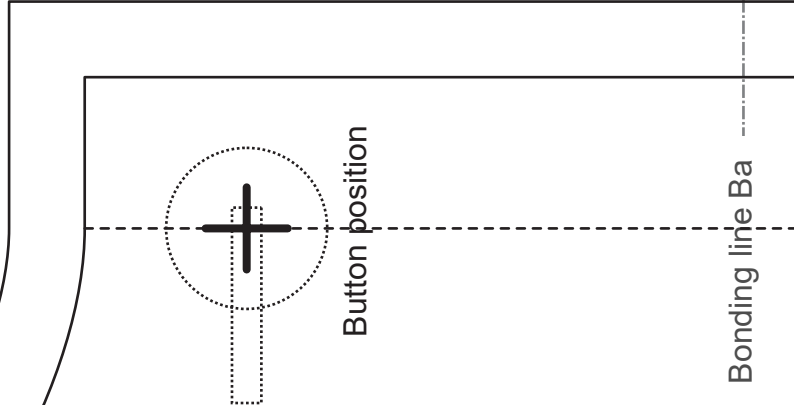

Facing line

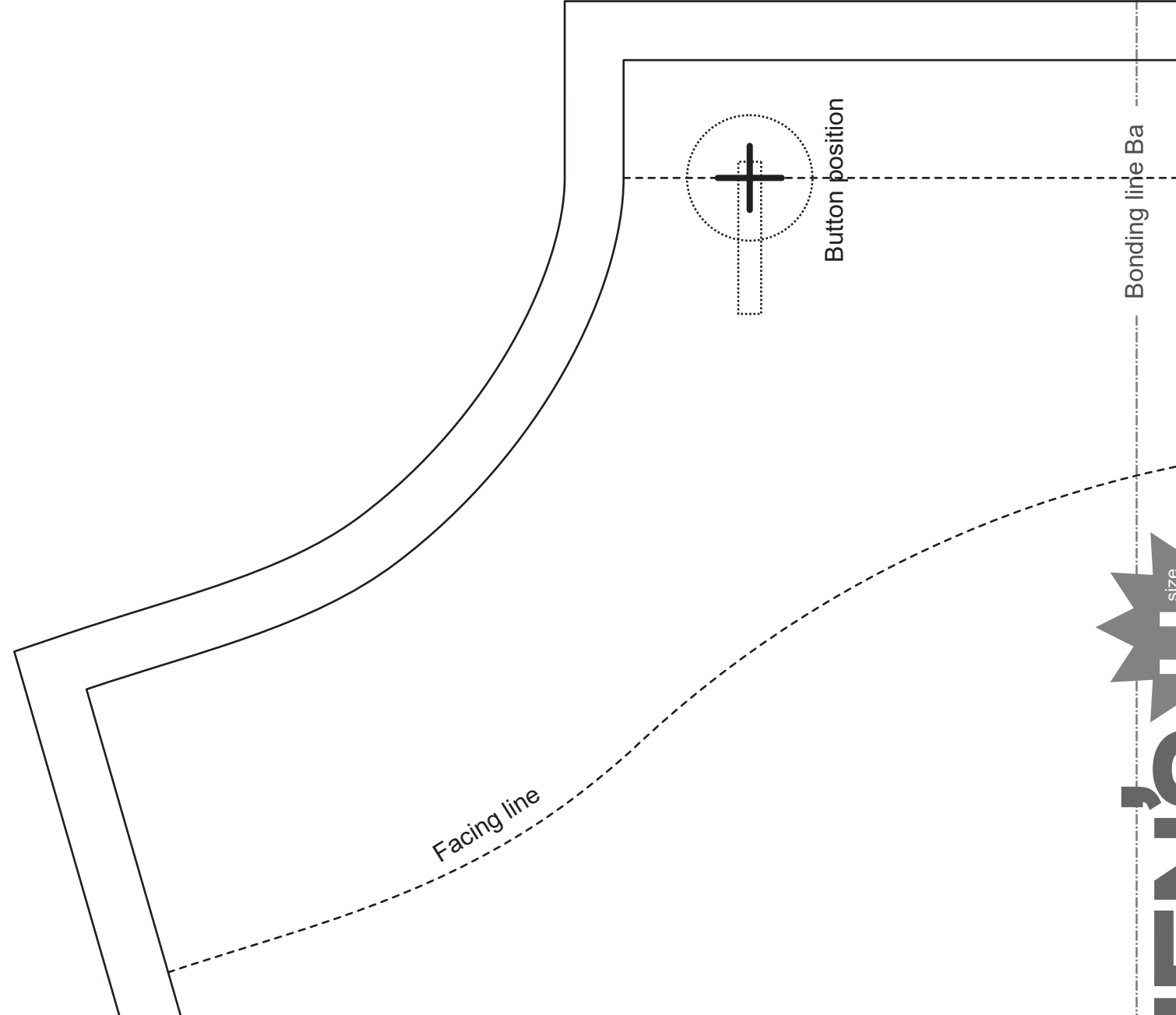

Bonding line AB

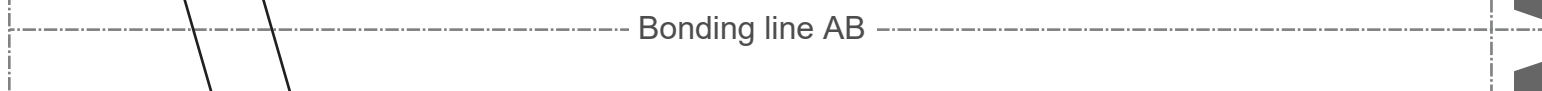

Bonding line AB

Grain Line

Bonding line Ca

Bonding line AC

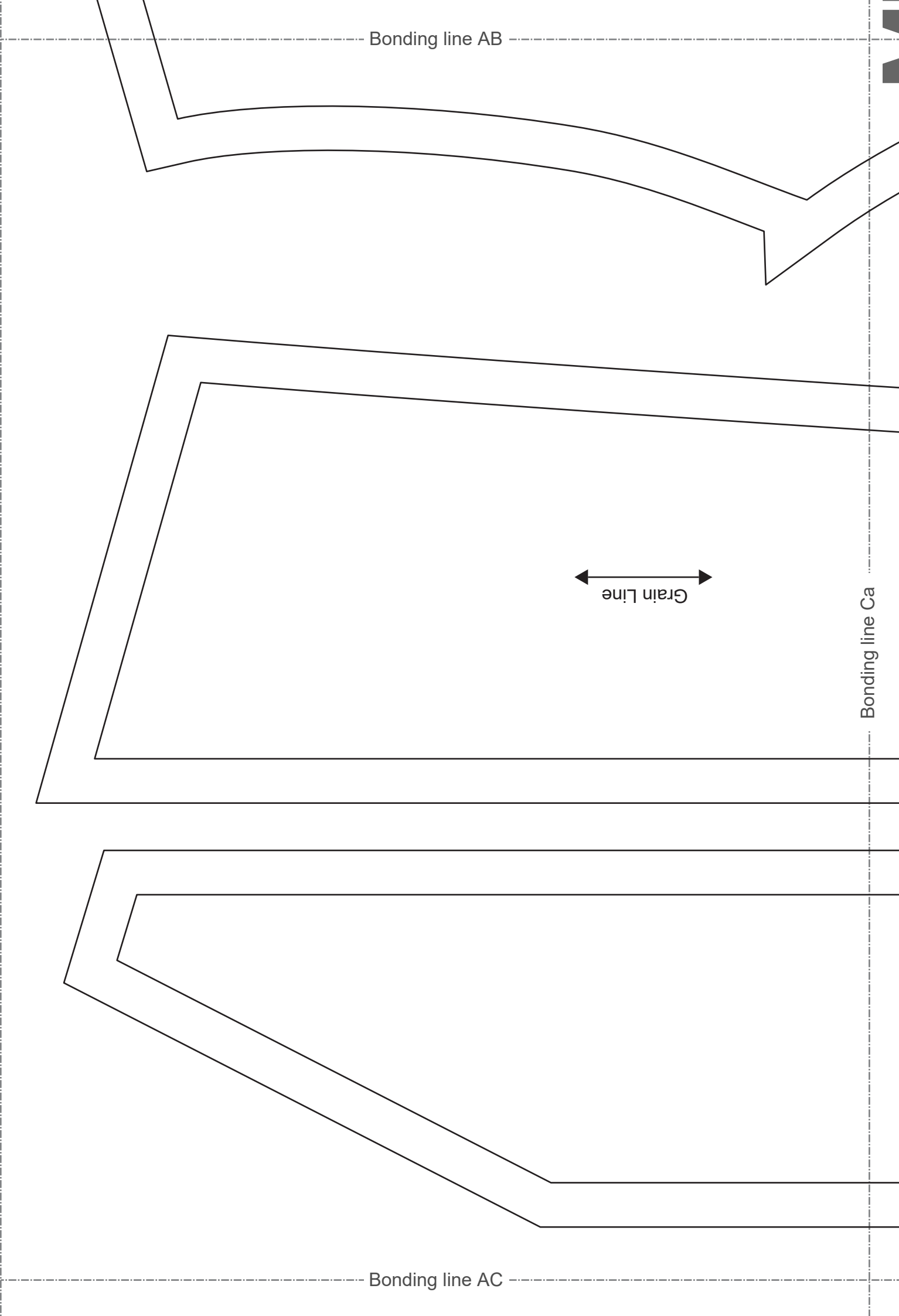

MEN'S



Bonding line

Neckband Vest
Front Fabric
Back Body
two sheets

Bonding line Aa



TDS

Bonding line BA

Vest
Body
Fabric
sheets

MEN'S ^{size} IT

Neckband Vest
Front Fabric
Front Body
two sheets

Bonding line BB

Bonding line Ba

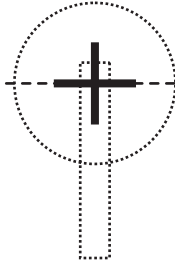
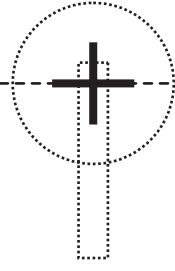

Bonding line Bb
Gr

Seam allowance 1cm

Seam allowance 1cm

MEN'S

Neckband Vest
Back Body
Lining Fabric
two sheets

Bonding line BA

M

Bonding line BB

Bonding line Ca

Bonding line Cb

Neckband Vest
Front Body
Lining Fabric
two sheets

Seam allowance 1cm

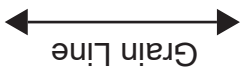

Neckband Vest
Facing
Fusible interlining
two sheets

Seam allowance 1

Bonding line BC

MEN'S

size

Bonding line

Seam allowance 1cm

Bonding line Ac

Grain Line

Bonding line CA

the
images,
ges,
sewing instructions.
eckbandvest.html



Bonding line CA

Grain Line



Please check here for the required fabric length images, cutting reference images, and the step-by-step sewing in <https://dr-cos.info/fp-neckband>

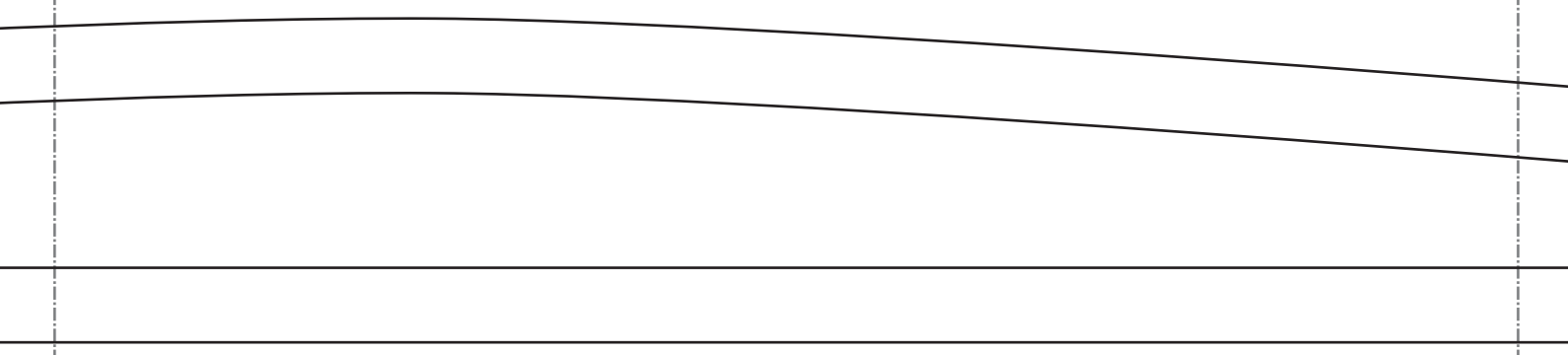

Bonding line Bb

Grain Line

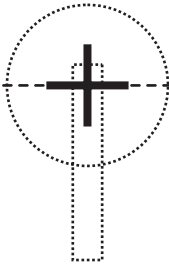

Bonding line Bc



Pocket position

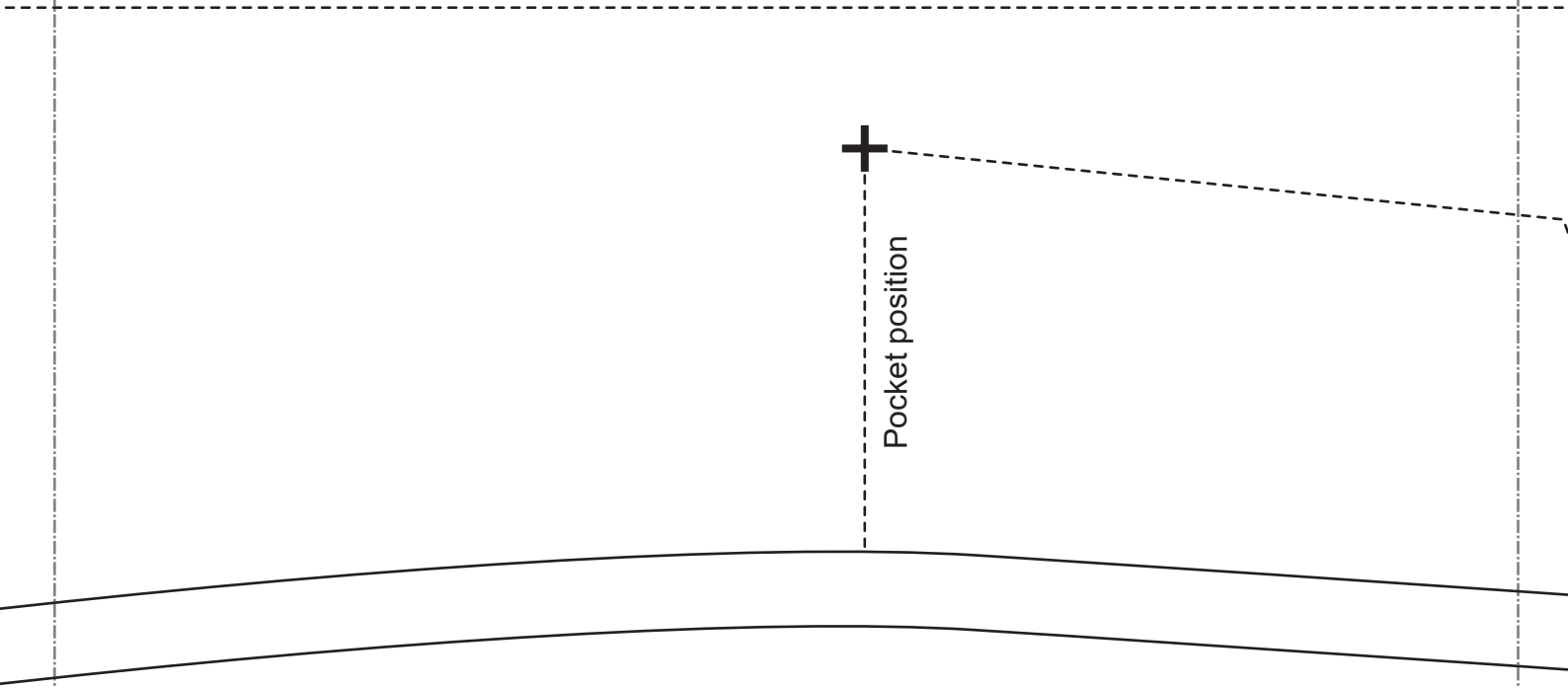

Bonding line CB

Bonding line CB

MEN'S **LL** size

Bonding line Cb

Bonding line Cc

Site: <https://dr-cos.info/en/>, <https://dr-cos.com/jp/>
MAIL: info@dr-cos.com
Twitter: <https://twitter.com/dr-cos>
Pinterest: <https://www.pinterest.jp/dr-cos/info>

MEN'S **LL** size

margin 1cm

Bonding line CC

Bonding line Ac

pintreread: https://www.pinterest.jp/drcosinfo

DRCOS

Twitter: https://twitter.com/drcos.com

MAIL: info@drcos.com

pintreread: https://www.pinterest.jp/drcosinfo

Facing line

Bonding line DA

Seam allowance 1cm

Grain Line

MEN'S size **LT**

Neckband Vest
Facing
Fusible interlining
one sheets

DRCOS
Twitter: https://twitter.com/drcos.com
MAIL: info@drcos.com
SITE: https://drcos.com/lt
pintreread: https://www.pinterest.jp/drcosinfo

Bonding line Ad



Bonding line DA

Bonding line Bc

Bonding line Bd

DRCOS

SITE <https://dr-cos.info/en> <https://dr-cos.com/jp>

MAIL info@dr-cos.com

Twitter [@drcos_com](https://twitter.com/@drcos_com)

Pinterest <https://www.pinterest.jp/drcosinfo>

Bonding line DB



Seam

Neck

From

two

Front
two

Bonding line DB

Bonding line Cc

Bonding line Cd

Bonding line DC

DRCOS
SITE <https://dr-cos.info/en> <https://dr-cos.com/jp>
MAIL info@dr-cos.com
Twitter <https://twitter.com/dr-cos>
Pinterest <https://www.pinterest.jp/dr-cos/info>

DRCOS
SITE <https://dr-cos.info/en> <https://dr-cos.com/jp>
MAIL info@dr-cos.com
Twitter <https://twitter.com/dr-cos>
Pinterest <https://www.pinterest.jp/dr-cos/info>

Neckband Vest
collar stand
Front Fabric
two sheets
Fusible interlining
one sheets



Grain Line

1cm

MEN'S ^{size} T

DRCOS
SITE <https://drcos-intel.com/>
MAIL info@drcos-intel.com info@drcos-intel.com
<https://www.intel.com/press/pressroom/>

Neckband Vest collar
Front Fabric two sheets
Fusible interlining one sheet

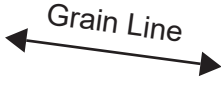

Seam allowance 1cm



Collar position

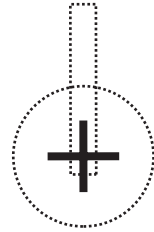

Button position

MEN'S ^{size} T



Seam allowance 1cm

cut

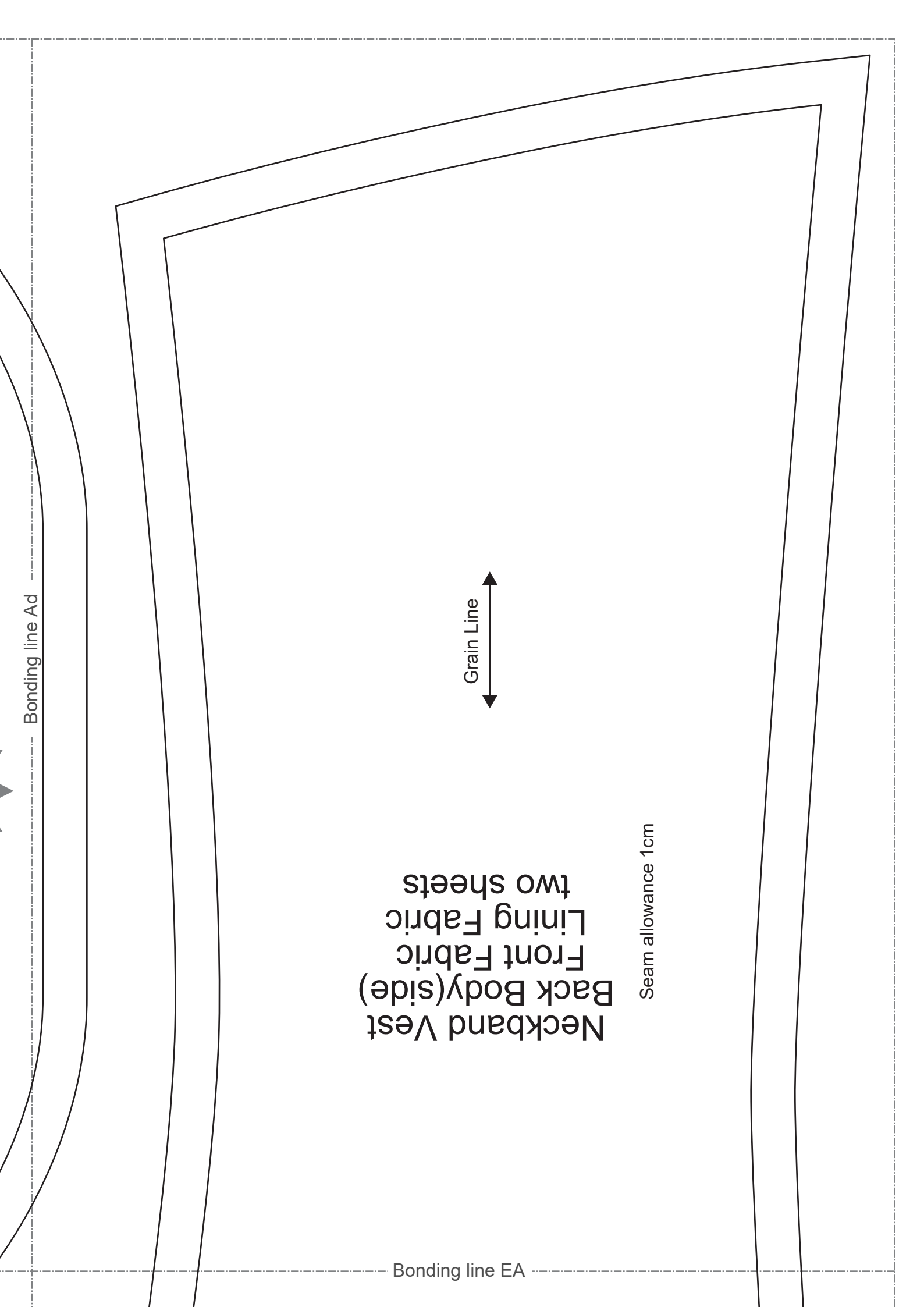

Bonding line EA

Neckband Vest
Back Body(side)
Front Fabric
Lining Fabric
two sheets

Seam allowance 1cm

Grain Line

Bonding line Ad

Bonding line EA



Bonding line Bd

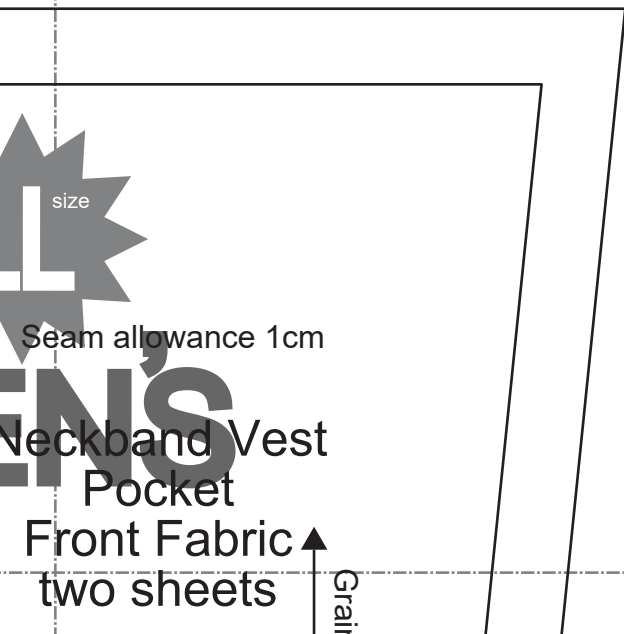

Grain

Bonding line EB

Front Fabric
two sheets

Grain Line

Bonding line EB

Bonding line Cd

DRCOS

SITE [https://dr-cos.info\(en\)](https://dr-cos.info(en)) [https://dr-cos.com\(jp\)](https://dr-cos.com(jp))
MAIL info@dr-cos.com
Twitter [@drcos_com](https://twitter.com/@drcos_com)
pinterest <https://www.pinterest.jp/drcosinfo>

MEN'S  size

Neckband Vest
Front Body(side)

Front Fabric

Lining Fabric

two sheets

Bonding line EB

Front Fabric Lining Fabric two sheets

Bonding line Dd

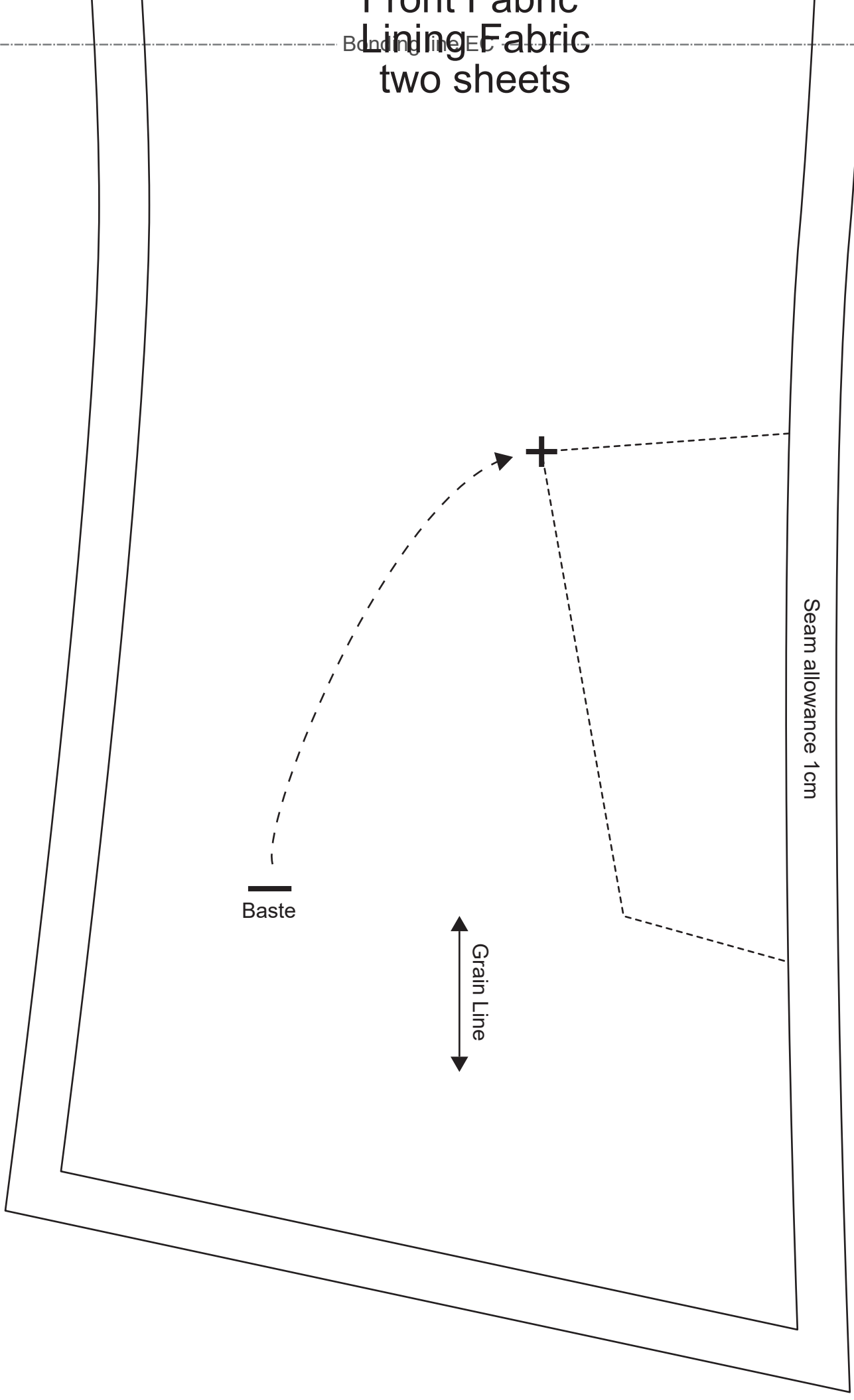

Seam allowance 1 cm

Grain Line

Baste