

**DRCOS**

SITE <http://dr-cos.info/en> <http://dr-cos.com/jp>  
MAIL [info@dr-cos.com](mailto:info@dr-cos.com)  
Twitter [https://twitter.com/@drcos\\_com](https://twitter.com/@drcos_com)  
facebook <https://www.facebook.com/drcoscom>

**MEN'S** size **S**

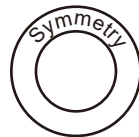

**Military Jacket  
Back Top Body  
one sheets**



Epaulette position

Bonding line Aa

Seam allowance 1/2in.

**DRCOS**

SITE <http://dr-cos.info/en> <http://dr-cos.com/jp>  
MAIL [info@dr-cos.com](mailto:info@dr-cos.com)  
Twitter [https://twitter.com/@drcos\\_com](https://twitter.com/@drcos_com)  
facebook <https://www.facebook.com/drcoscom>

Bonding line AA

MEN'S  S

Military Jacket  
Back Bottom Body  
Two sheets

Bonding line AB



Grain Line

Bonding line Ca

Seam allowance 1/2in.

Bonding line AC

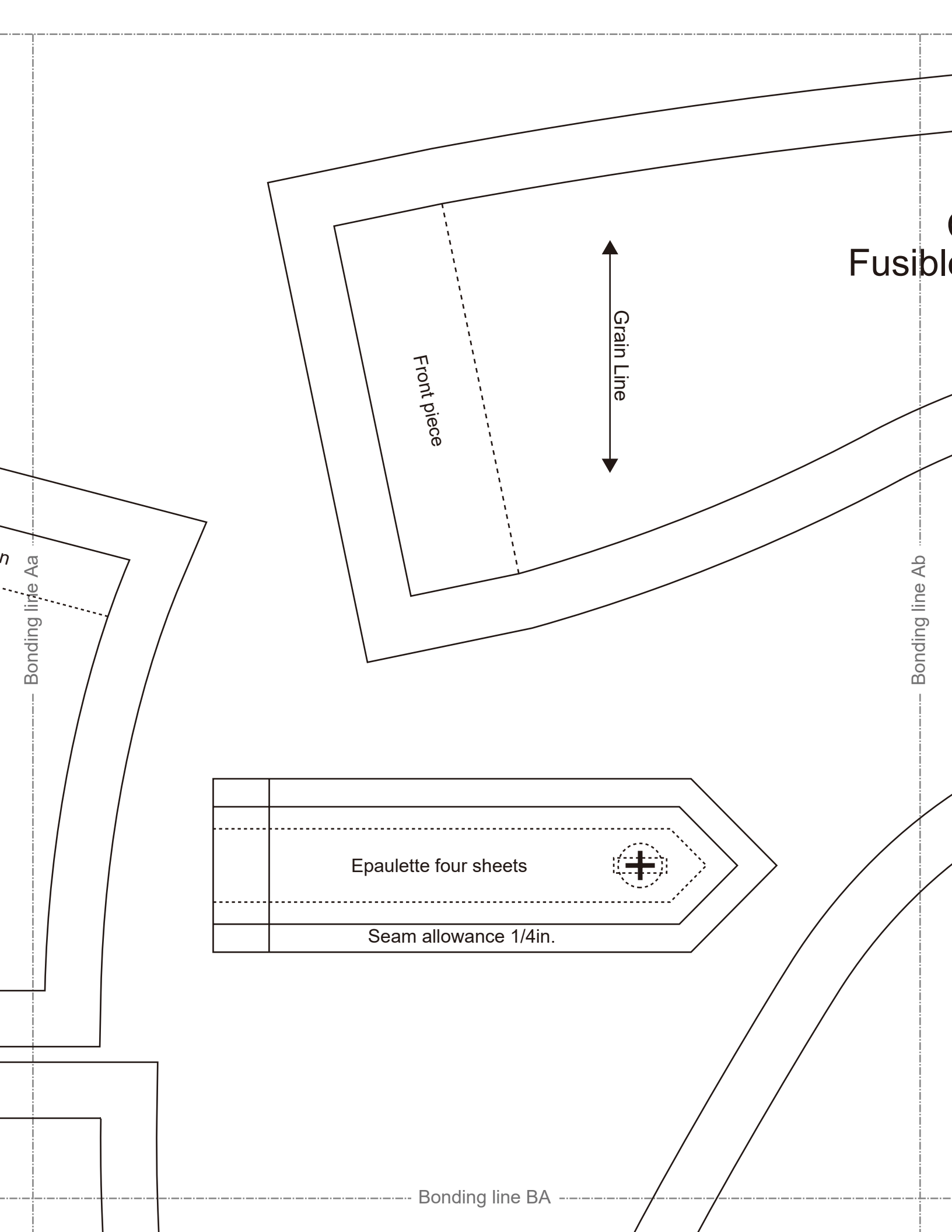

Bonding line BA

Front

Bonding line Ba

Bonding line Bb

Bonding line BB

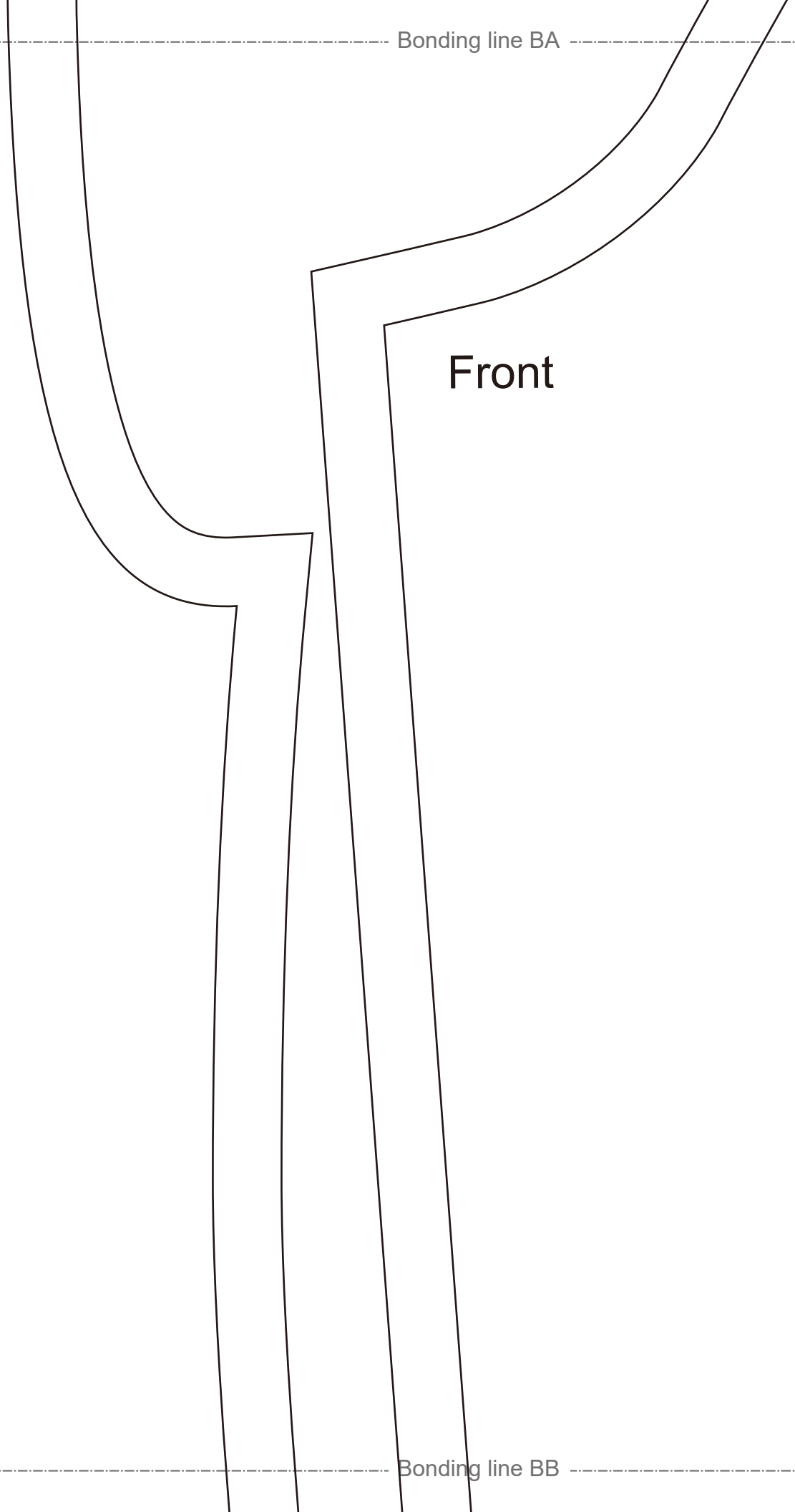

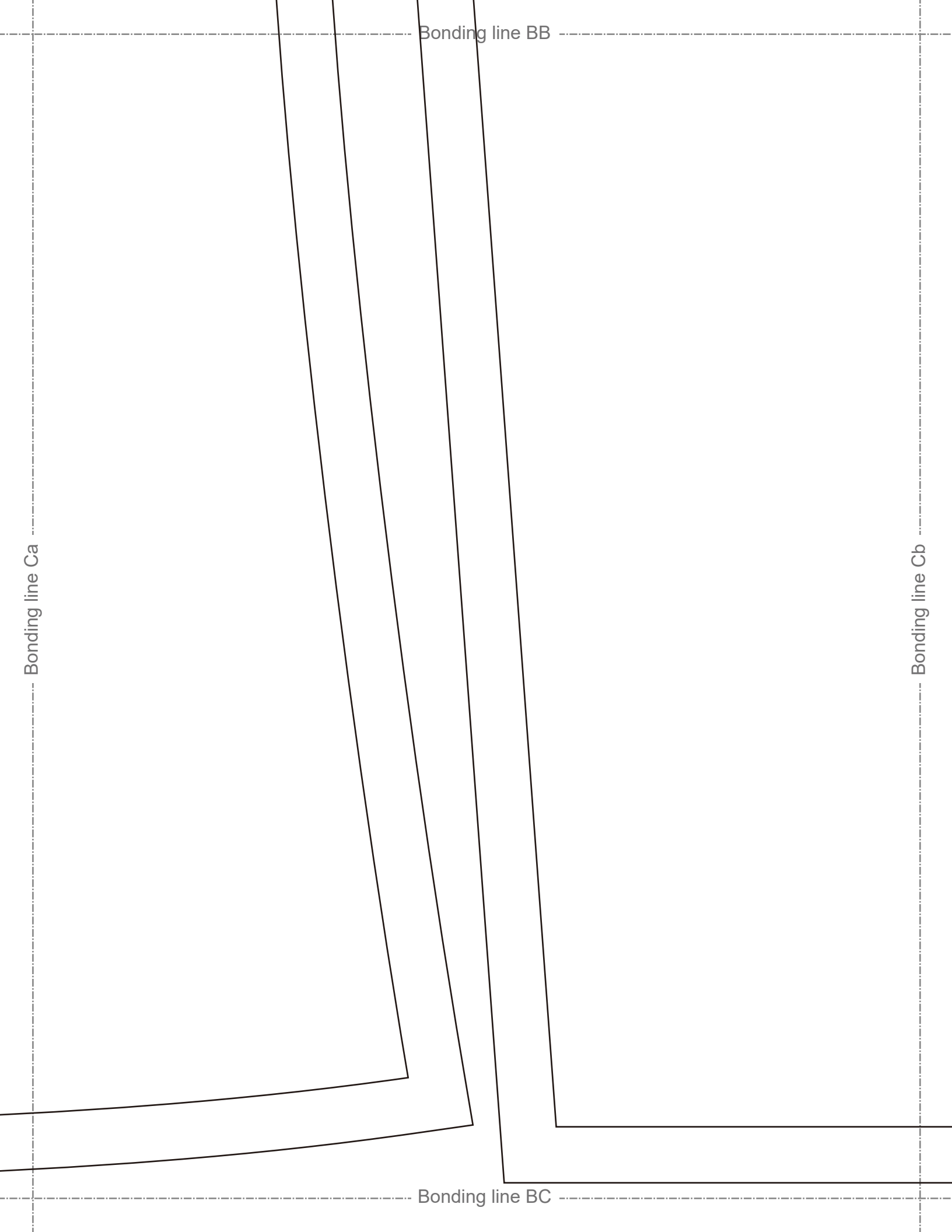

Military Jacket  
Collar two sheets  
visible interlining one sheets

MEN'S

Seam allowance 1/2in.

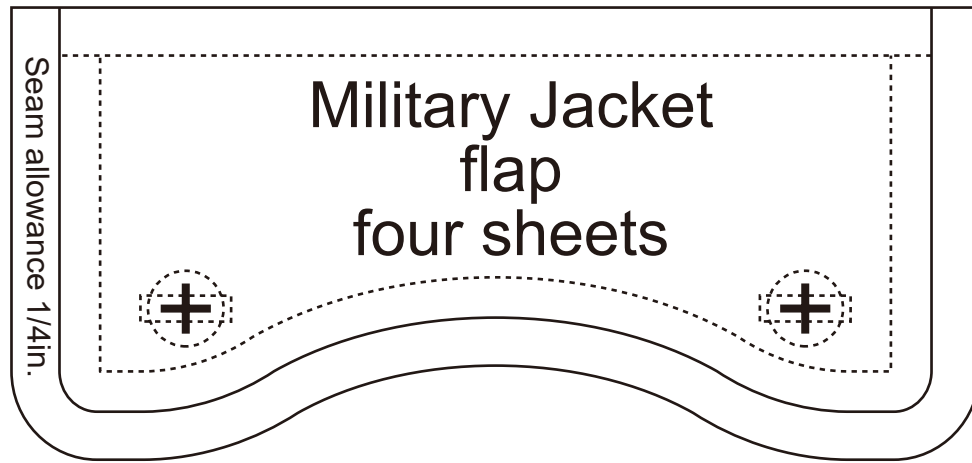

Bonding line Ab

Bonding line Ac

**DRCOS**  
SITE [http://dr-cos.info\(en\)](http://dr-cos.info(en)) [http://dr-cos.com\(jp\)](http://dr-cos.com(jp))  
MAIL [info@dr-cos.com](mailto:info@dr-cos.com)  
Twitter [https://twitter.com/@drcos\\_com](https://twitter.com/@drcos_com)  
facebook <https://www.facebook.com/drcoscom>

Bonding line CA

Bonding line CA

Bonding line Bb

**MEN'S**  **S**

Bonding line Bc

**Military Jacket  
Sleeve  
two sheets**

Bonding line CB



Bonding line CB



Grain Line

Bonding line Cb

Bonding line Cc

Seam allowance 1/2in.

Bonding line CC

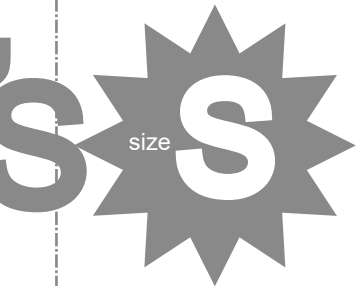

# DRCOS

SITE [http://dr-cos.info\(en\)](http://dr-cos.info(en)) [http://dr-cos.com\(jp\)](http://dr-cos.com(jp))  
MAIL [info@dr-cos.com](mailto:info@dr-cos.com)  
Twitter [https://twitter.com/@drcos\\_com](https://twitter.com/@drcos_com)  
facebook <https://www.facebook.com/drcoscom>

Bonding line Ac

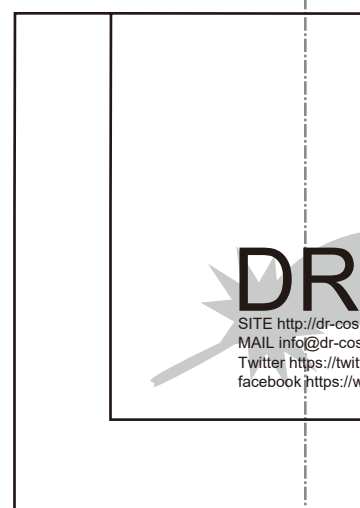

# DR

SITE [http://dr-cos.info\(en\)](http://dr-cos.info(en)) [http://dr-cos.com\(jp\)](http://dr-cos.com(jp))  
MAIL [info@dr-cos.com](mailto:info@dr-cos.com)  
Twitter [https://twitter.com/@drcos\\_com](https://twitter.com/@drcos_com)  
facebook <https://www.facebook.com/drcoscom>

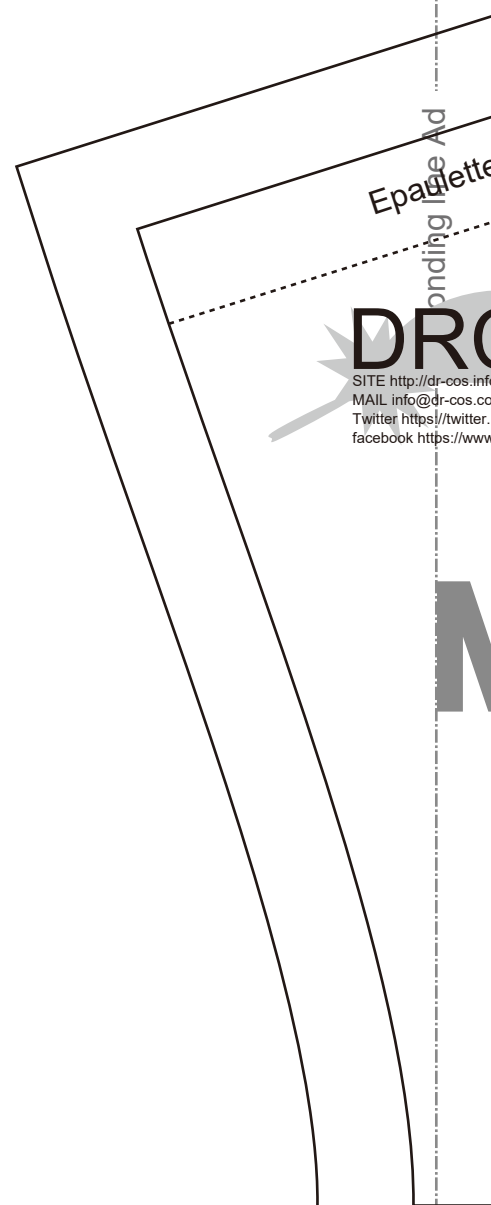

# DR

SITE [http://dr-cos.info\(en\)](http://dr-cos.info(en)) [http://dr-cos.com\(jp\)](http://dr-cos.com(jp))  
MAIL [info@dr-cos.com](mailto:info@dr-cos.com)  
Twitter [https://twitter.com/@drcos\\_com](https://twitter.com/@drcos_com)  
facebook <https://www.facebook.com/drcoscom>

Epape Ad

Bonding line Ac

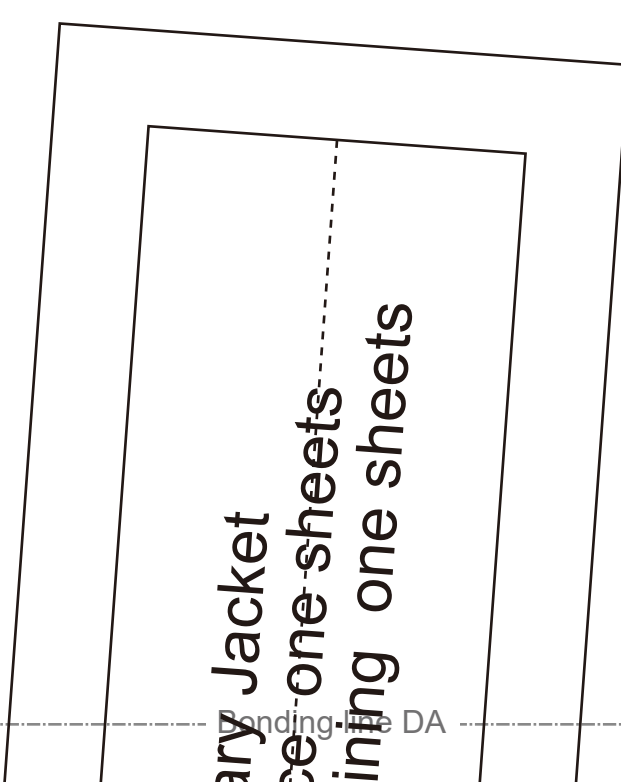

ary Jacket  
ce one sheets  
ining one sheets

Bonding line DA

Bonding line Bc

Back

Military J  
Front-piece of  
Fusible interlining



Seam allowance 1/2in.

**DRCOS**

SITE [http://dr-cos.info\(en\)](http://dr-cos.info(en)) [http://dr-cos.com\(jp\)](http://dr-cos.com(jp))  
MAIL [info@dr-cos.com](mailto:info@dr-cos.com)  
Twitter [https://twitter.com/@drcos\\_com](https://twitter.com/@drcos_com)  
facebook <https://www.facebook.com/drcos.com>

Bonding line Bc



Bonding line DB

**Baste**

**ME**

Bonding line Cc

**DRCOS**

SITE <http://dr-cos.info/en> <http://dr-cos.com/jp>  
MAIL [info@dr-cos.com](mailto:info@dr-cos.com)  
TWITTER [https://twitter.com/dr-cos\\_com](https://twitter.com/dr-cos_com)  
FACEBOOK <https://www.facebook.com/drcos.com>

**MEN'S**

Bonding line DB

Seam allowance 1/2in.

Bonding line DC

Baste

Bonding line Cd

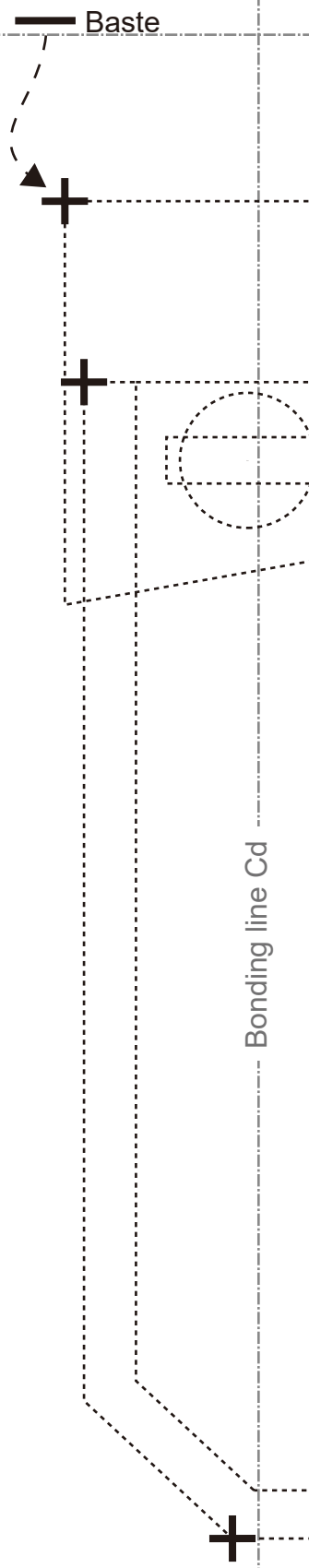

**DRCOS**

Website [http://dr-cos.info\(en\)](http://dr-cos.info(en)) [http://dr-cos.com\(jp\)](http://dr-cos.com(jp))  
Email [info@dr-cos.com](mailto:info@dr-cos.com)  
Twitter [https://twitter.com/drcos\\_com](https://twitter.com/drcos_com)  
Facebook <https://www.facebook.com/drcoscom>

**MEN'S**

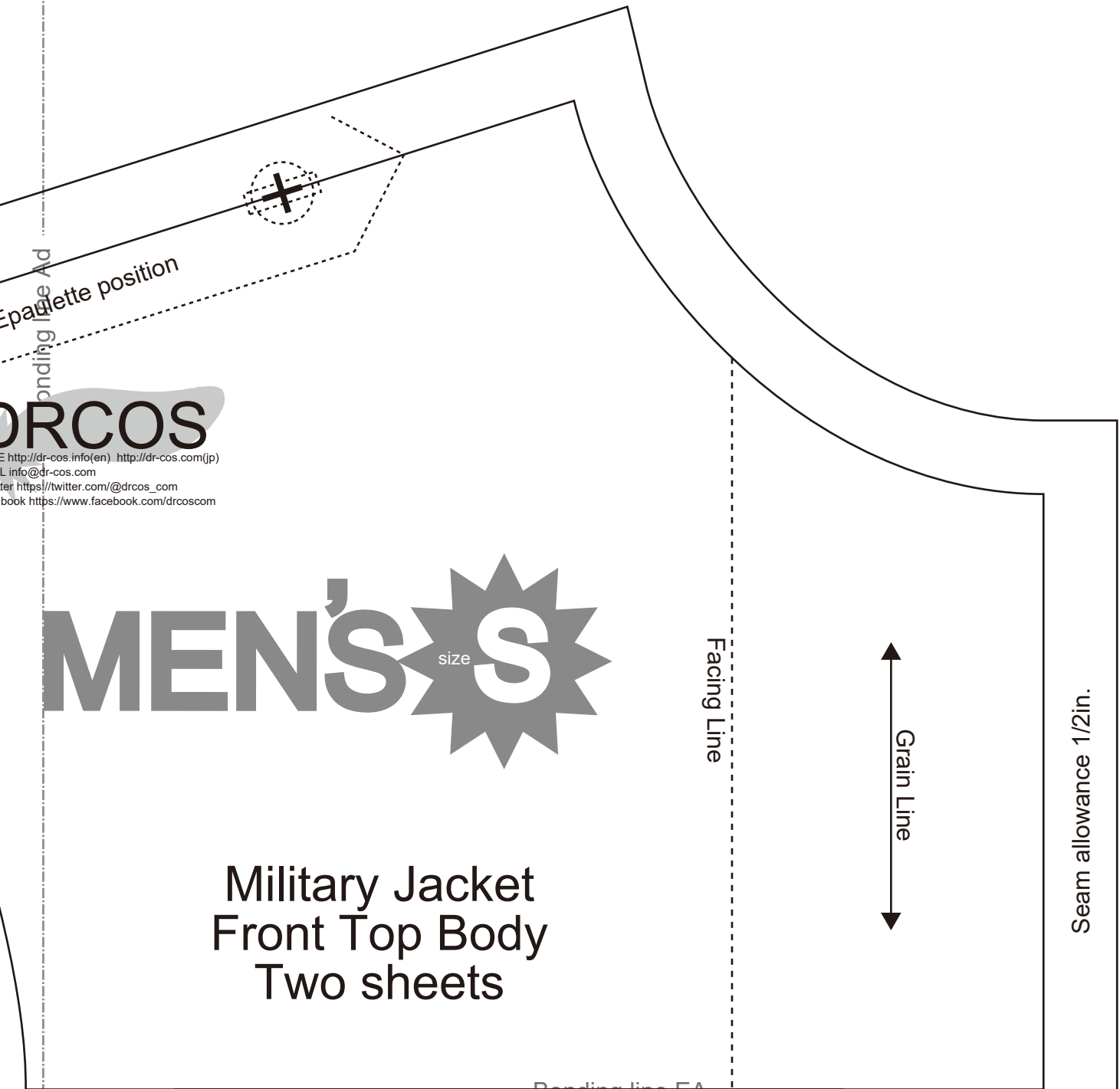

Epaulette position

**DRCOS**

Website [http://dr-cos.info\(en\)](http://dr-cos.info(en)) [http://dr-cos.com\(jp\)](http://dr-cos.com(jp))  
Email [info@dr-cos.com](mailto:info@dr-cos.com)  
Twitter [https://twitter.com/drcos\\_com](https://twitter.com/drcos_com)  
Facebook <https://www.facebook.com/drcoscom>

**MEN'S** size **S**

Military Jacket  
Front Top Body  
Two sheets

Facing Line

Grain Line

Seam allowance 1/2in.

Bonding line FA

Flap position

Bonding line Ae

Bonding line FA

Flap position

Pocket position

Bonding line Bc

Bonding line Be

Facing Line

Bonding line EB

MEN'S size S

OS  
dr-cos.com(jp)  
s.com  
om/drcos.com

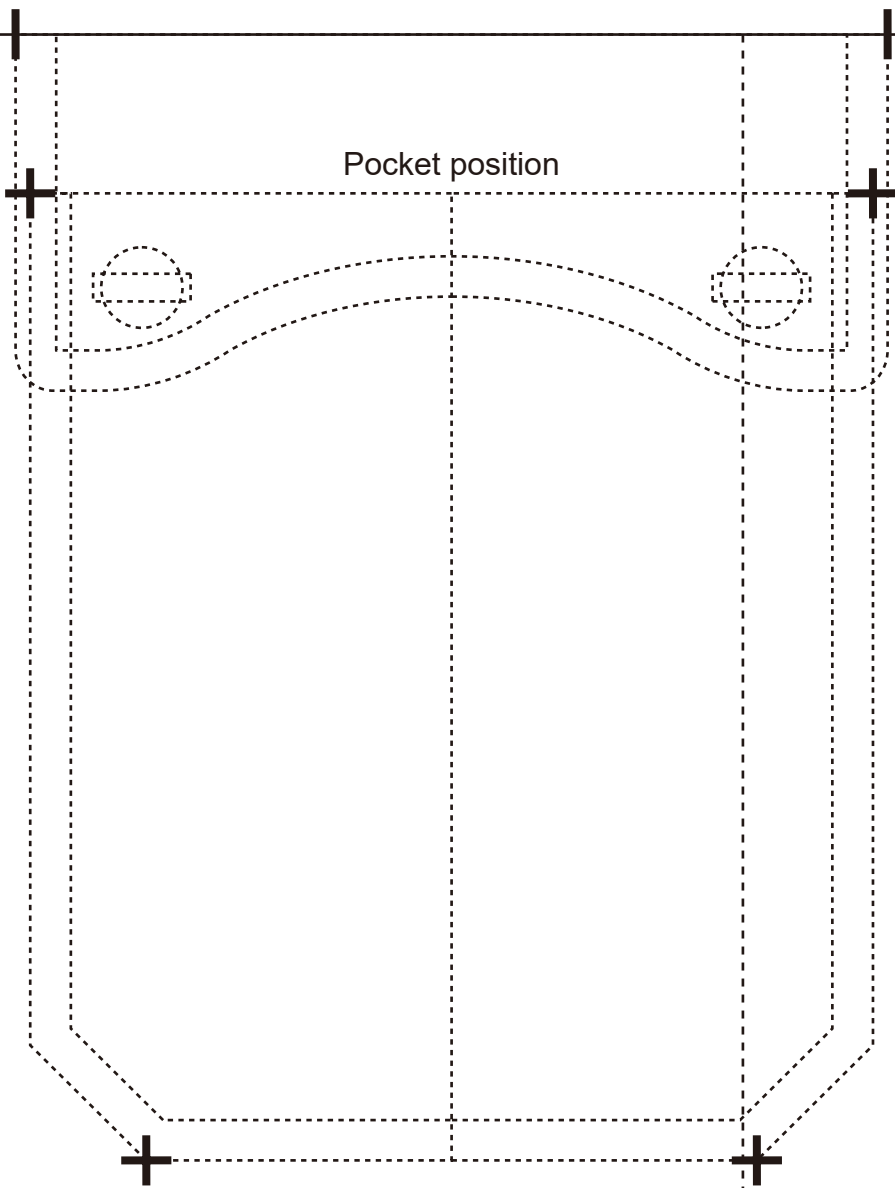

Bonding line EB

Pocket position

Grain Line

Bonding line Cd

# Military Jacket Front Bottom Body Two sheets

Bonding line Ce

Open fastener position

Bonding line EC

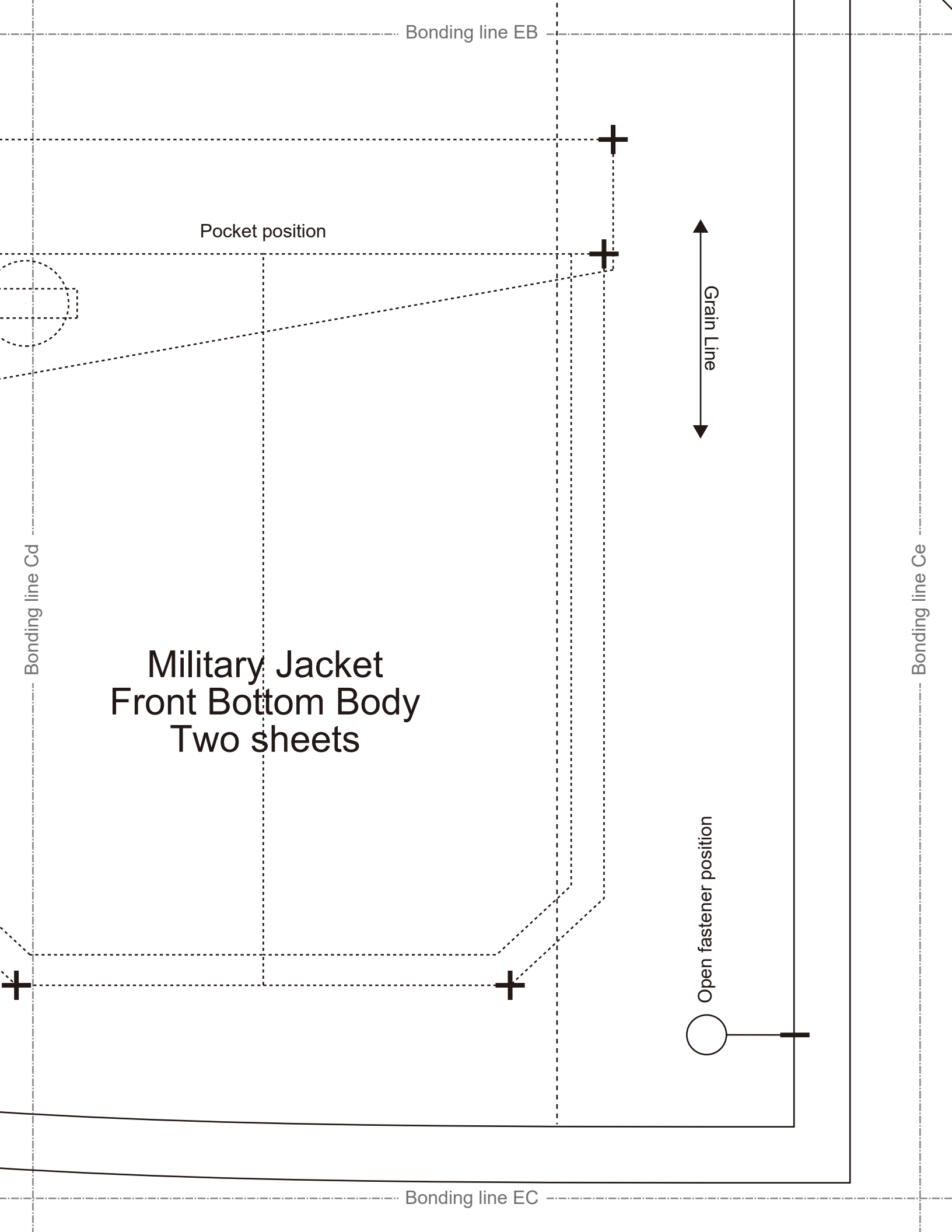

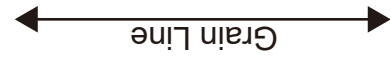
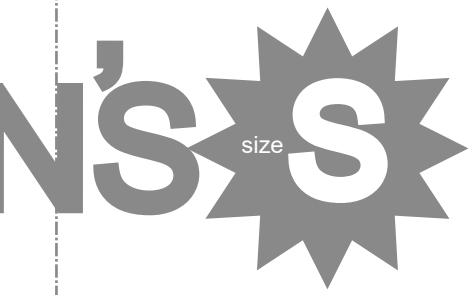

Seam allowance 1/2in.

Bonding line Ae

Bonding line Af

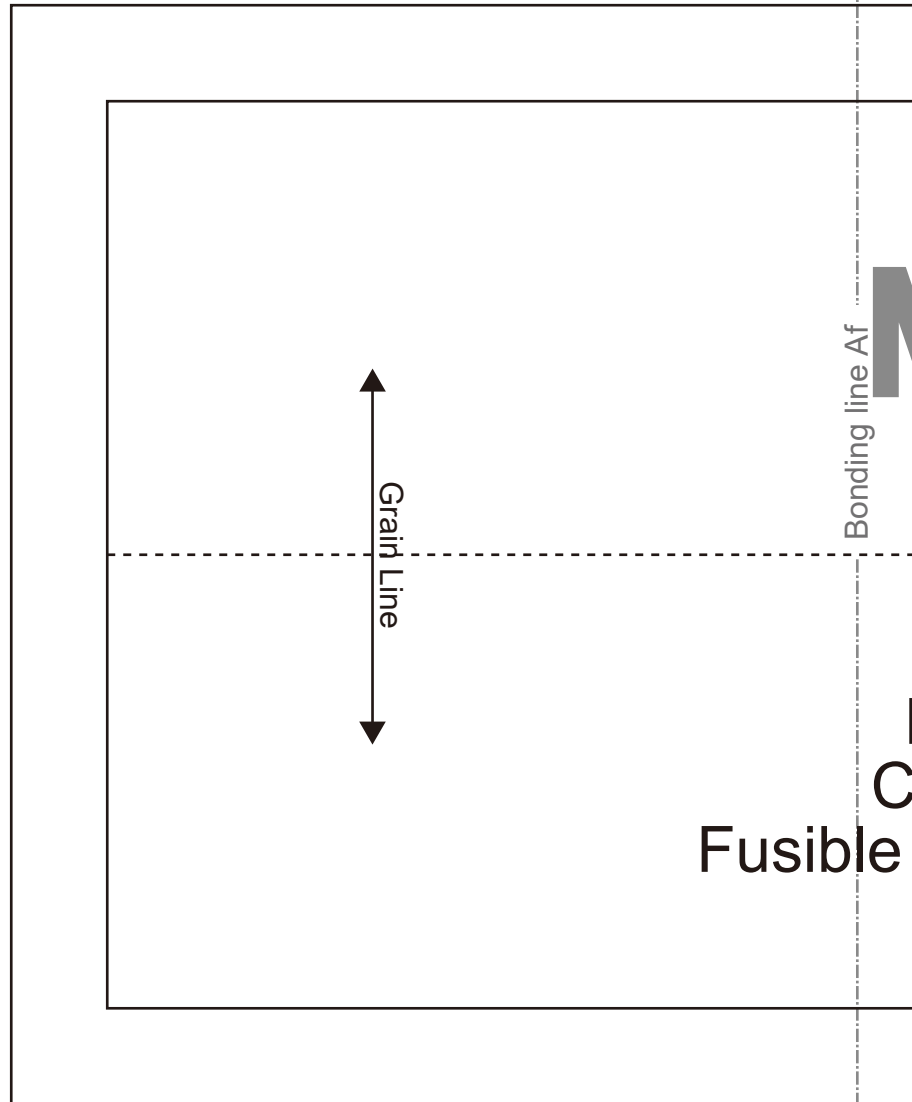

Fusible

Seam allowance 1/2in.

two sheets  
nap

Bonding line FA



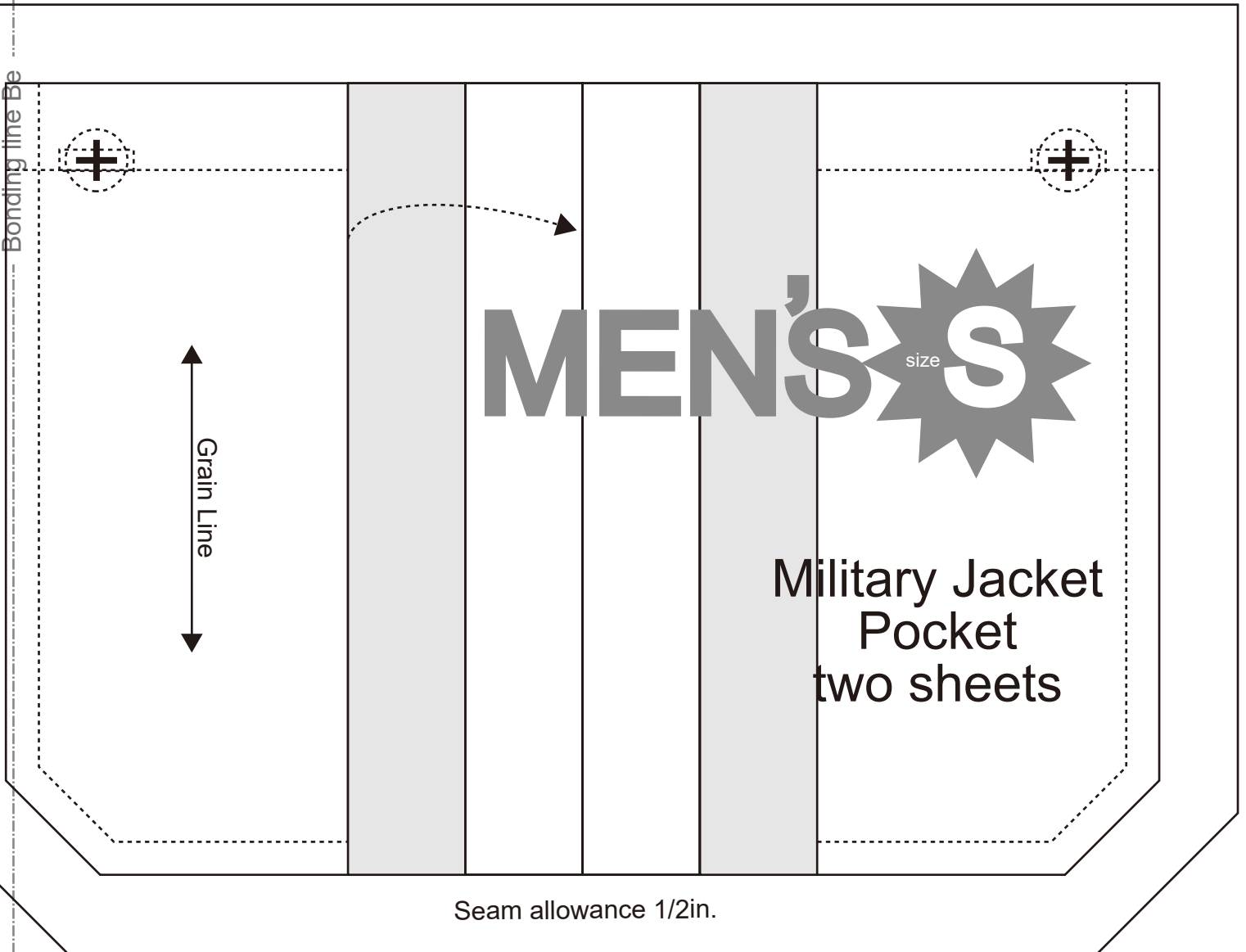
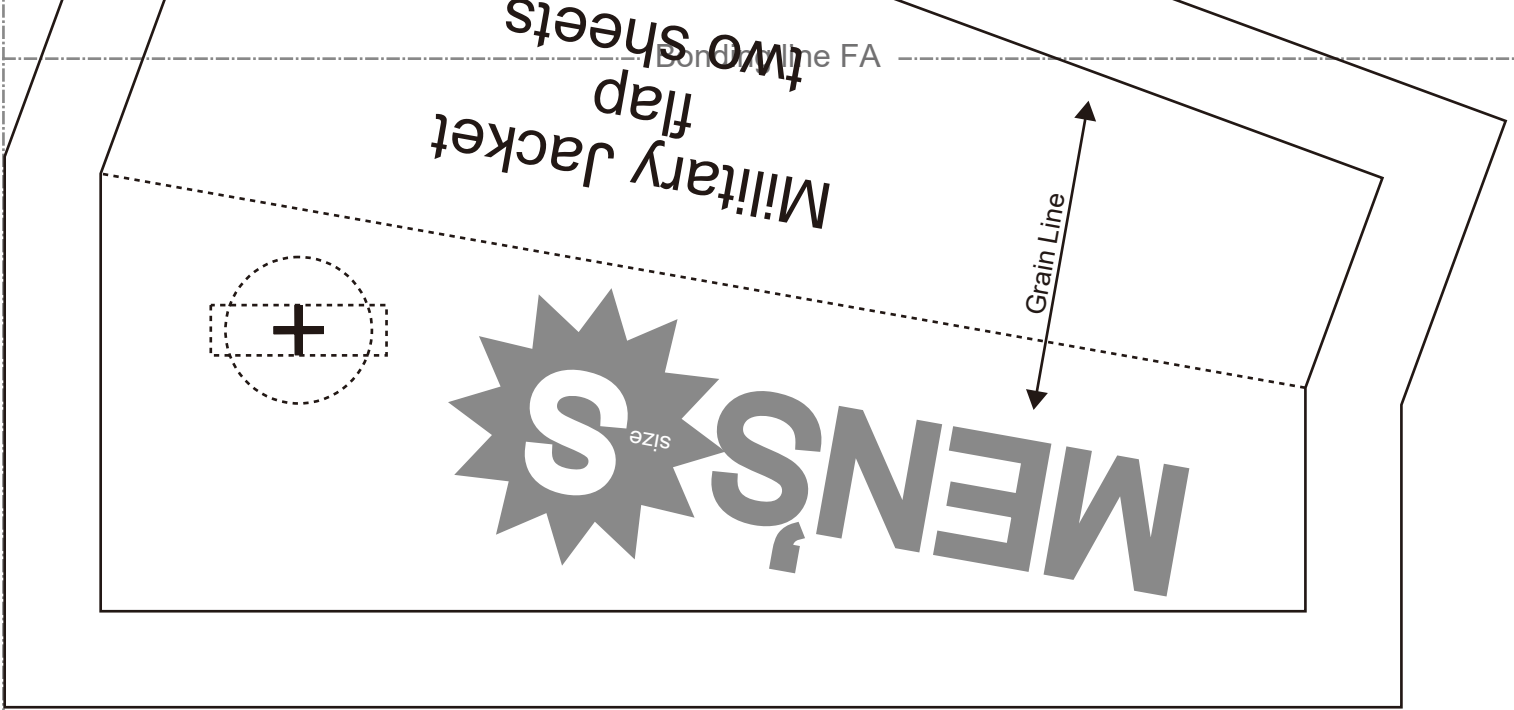

Military Jacket  
Facing two sheets  
Fusible interlining two sheets

Bonding line Af

**MEN'S**  **S**  
size

Military Jacket  
Cuffs two sheets  
Fusible interlining two sheets

**DRCOS**  
SITE <http://dr-cos.info/en> <http://dr-cos.com/jp>  
MAIL [info@dr-cos.com](mailto:info@dr-cos.com)  
Twitter [https://twitter.com/drcos\\_com](https://twitter.com/drcos_com)  
facebook <https://www.facebook.com/drcoscom>

Seam allowance 1/2in.

Bonding line GA

Bonding line GA

Bonding line Bf

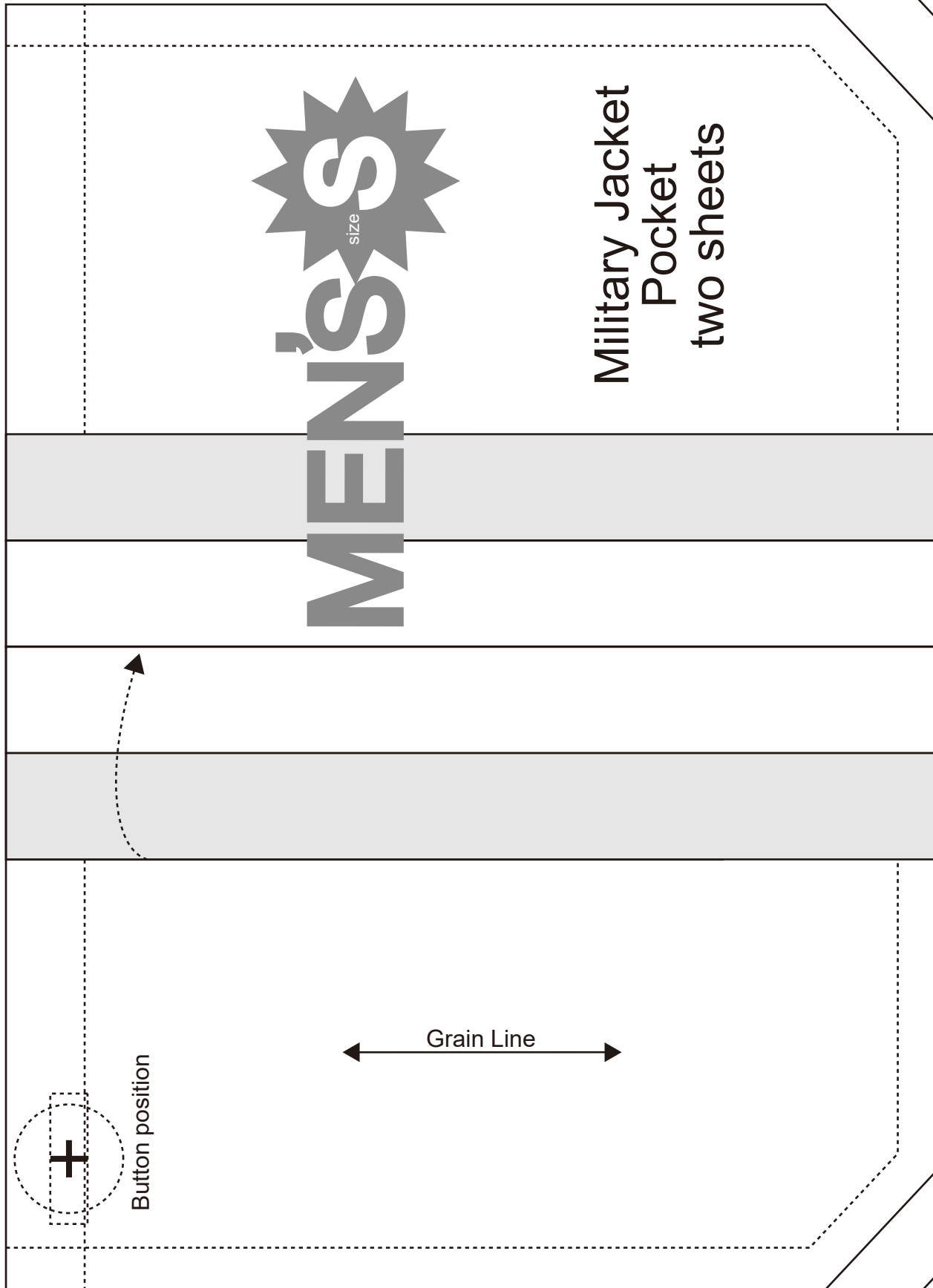

**MEN'S**  
size

**Military Jacket  
Pocket  
two sheets**

Button position

Grain Line

Seam allowance 1/2in.

Bonding line GB