

Printer blocks
Front Body
two sheets

Bonding line AA



Bonding line Aa

DRCOS
SITE <http://dr-cos.info/en> <http://dr-cos.com.jp>
MAIL info@dr-cos.com
Twitter https://twitter.com/dr-cos_com
facebook <https://www.facebook.com/drcoscom>

Seam allowance 1/2in.

Knickerbockers
Front Body



Bonding line AA

Bonding line Ba



Bonding line AB



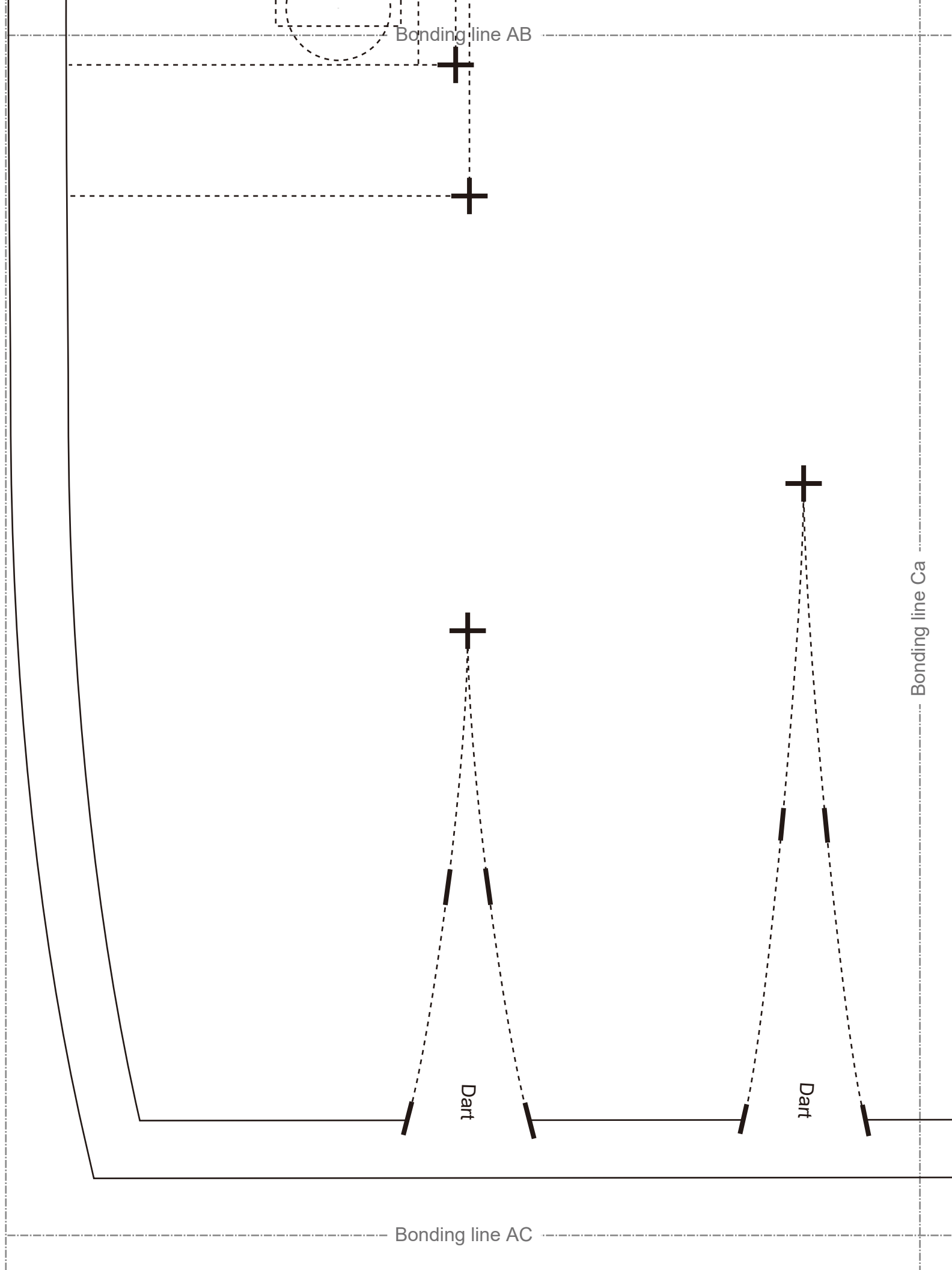

Bonding line AC

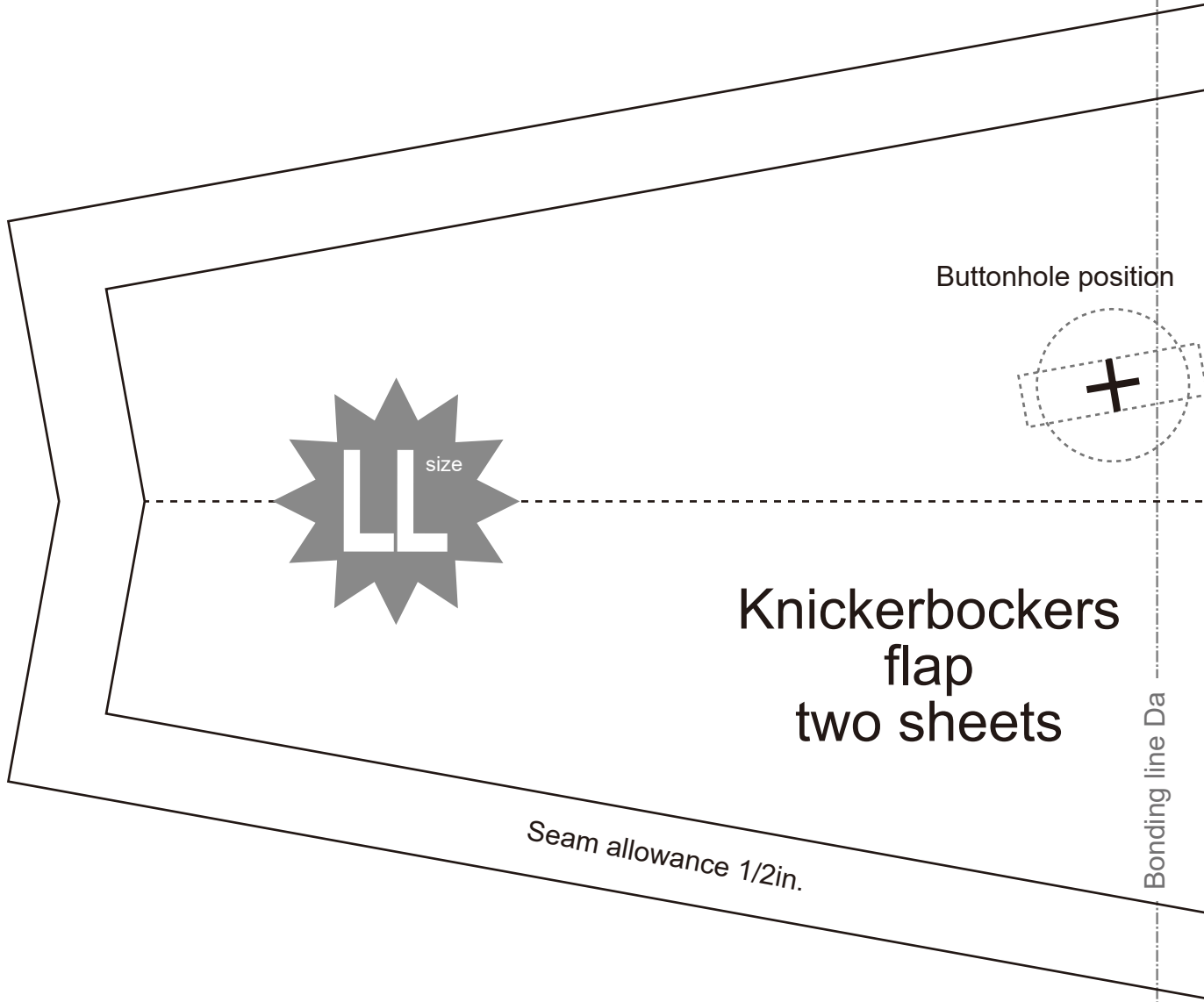

Buttonhole position

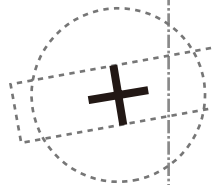

Knickerbockers
flap
two sheets

Bonding line Da

Seam allowance 1/2in.

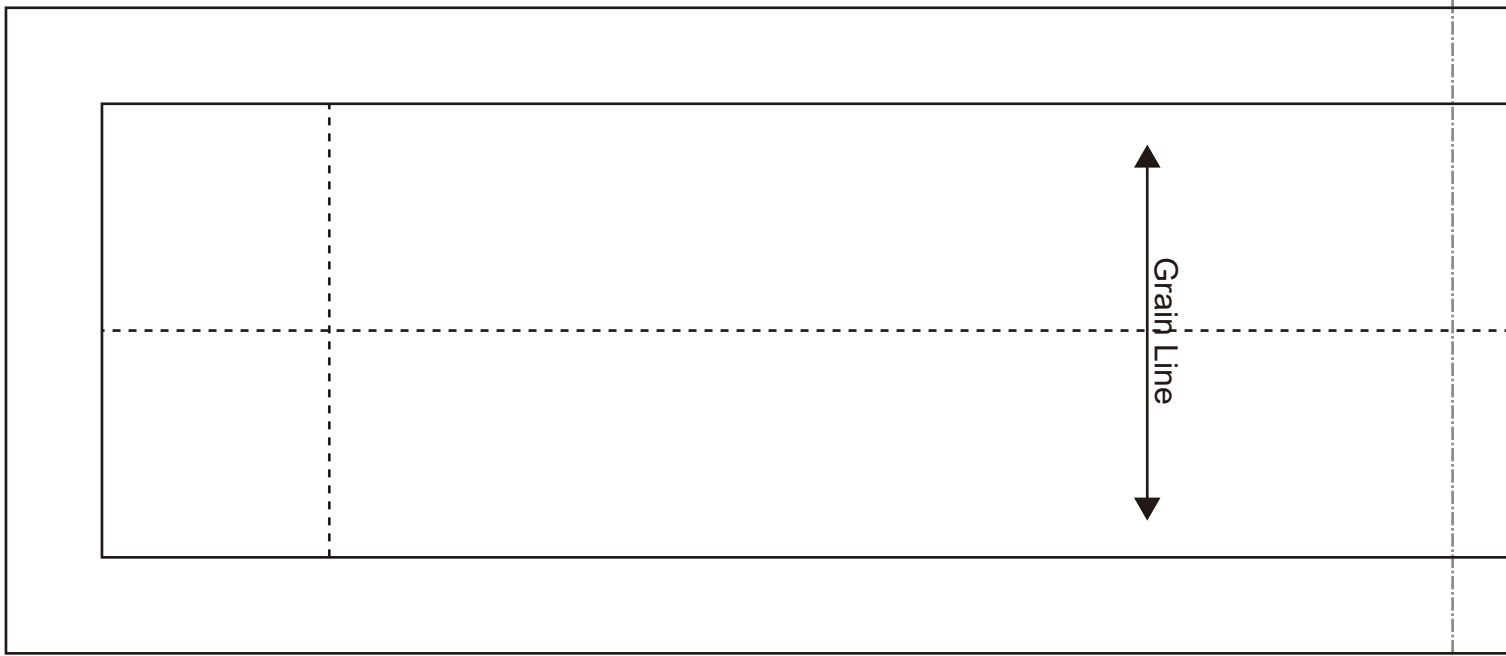

Grain Line

Bonding line AD

Bonding line Aa

Bonding line BA

Bonding line Ab

W

Bonding line Ba

Bonding line BA

Bonding line Bb

Bonding line BB

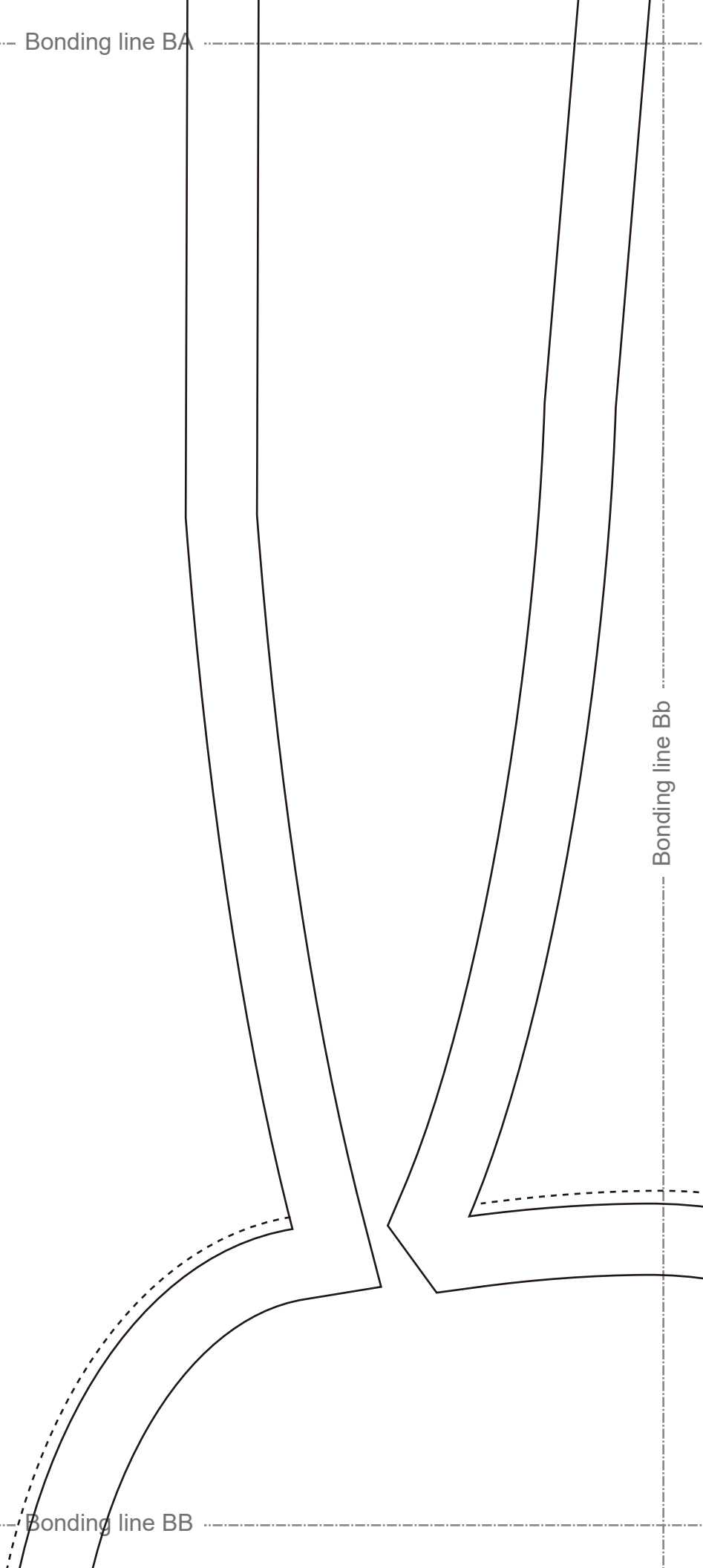

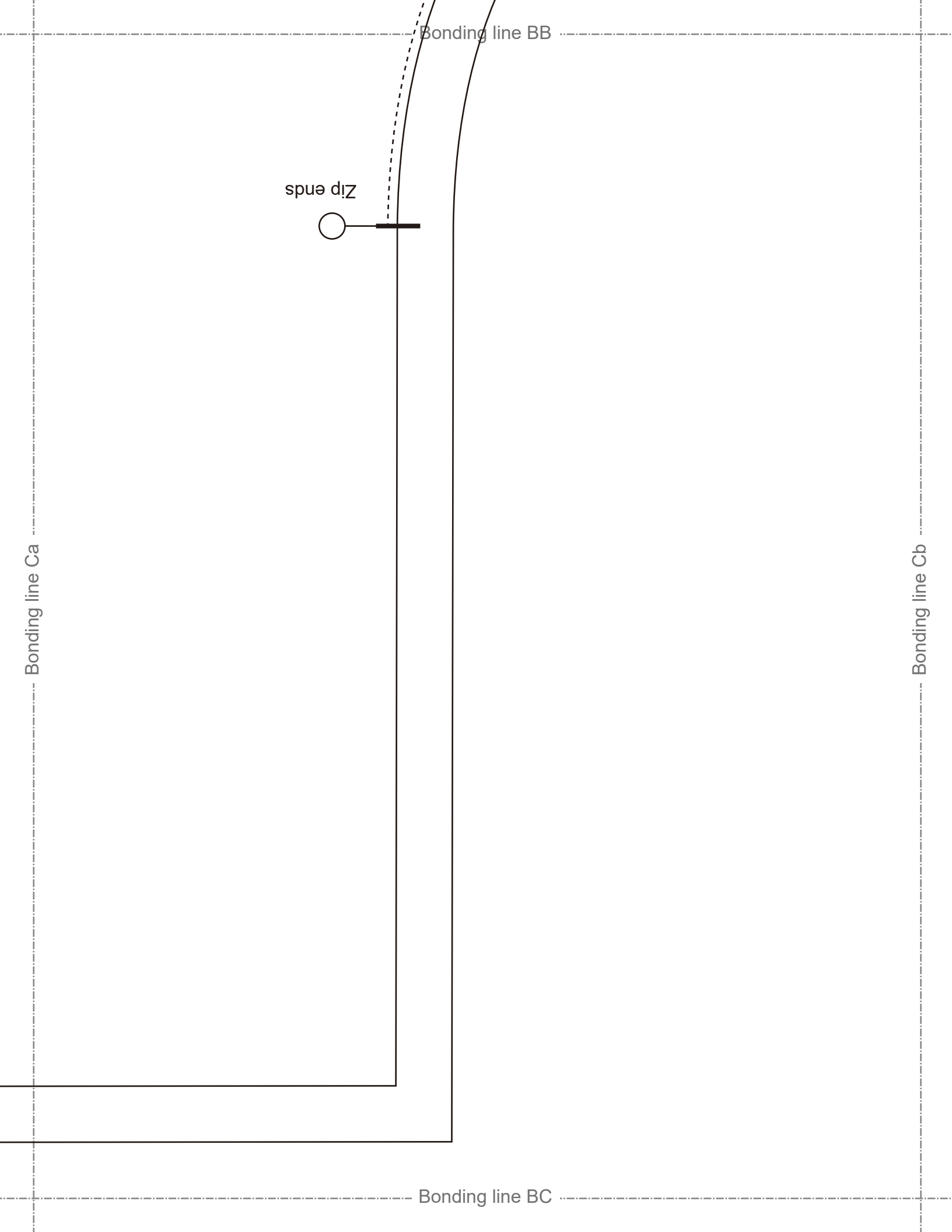

Bonding line BC

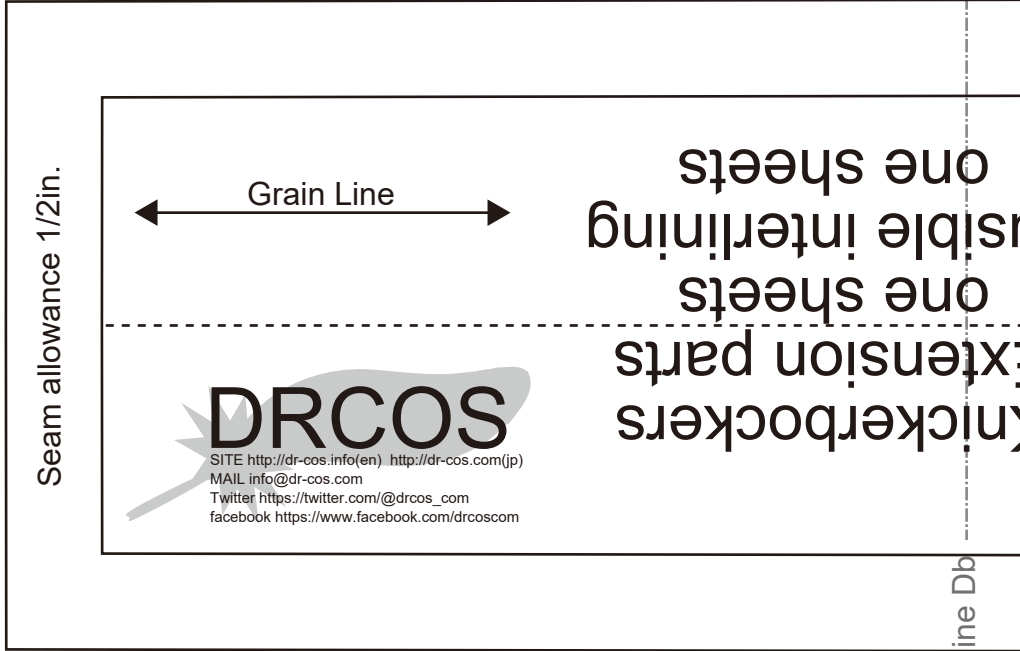
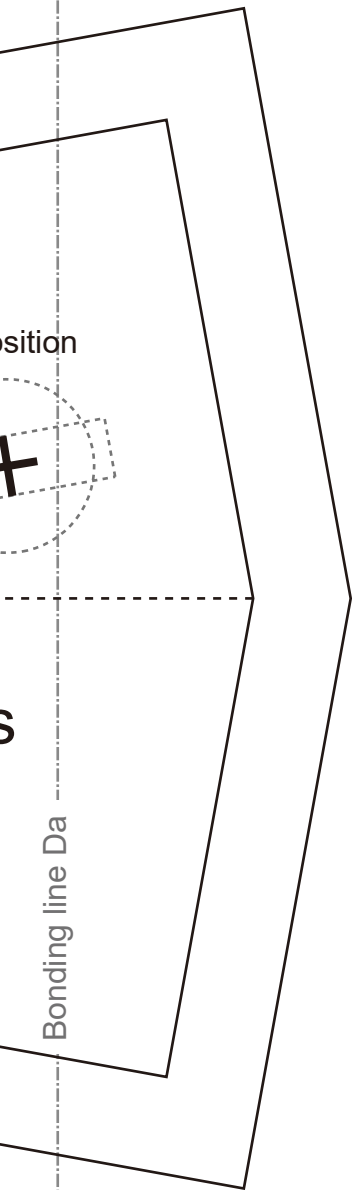

Bonding line Db

Seam

Knickerbockers
Belt
one sheets
Fusible interlining
one sheets

Bonding line BD

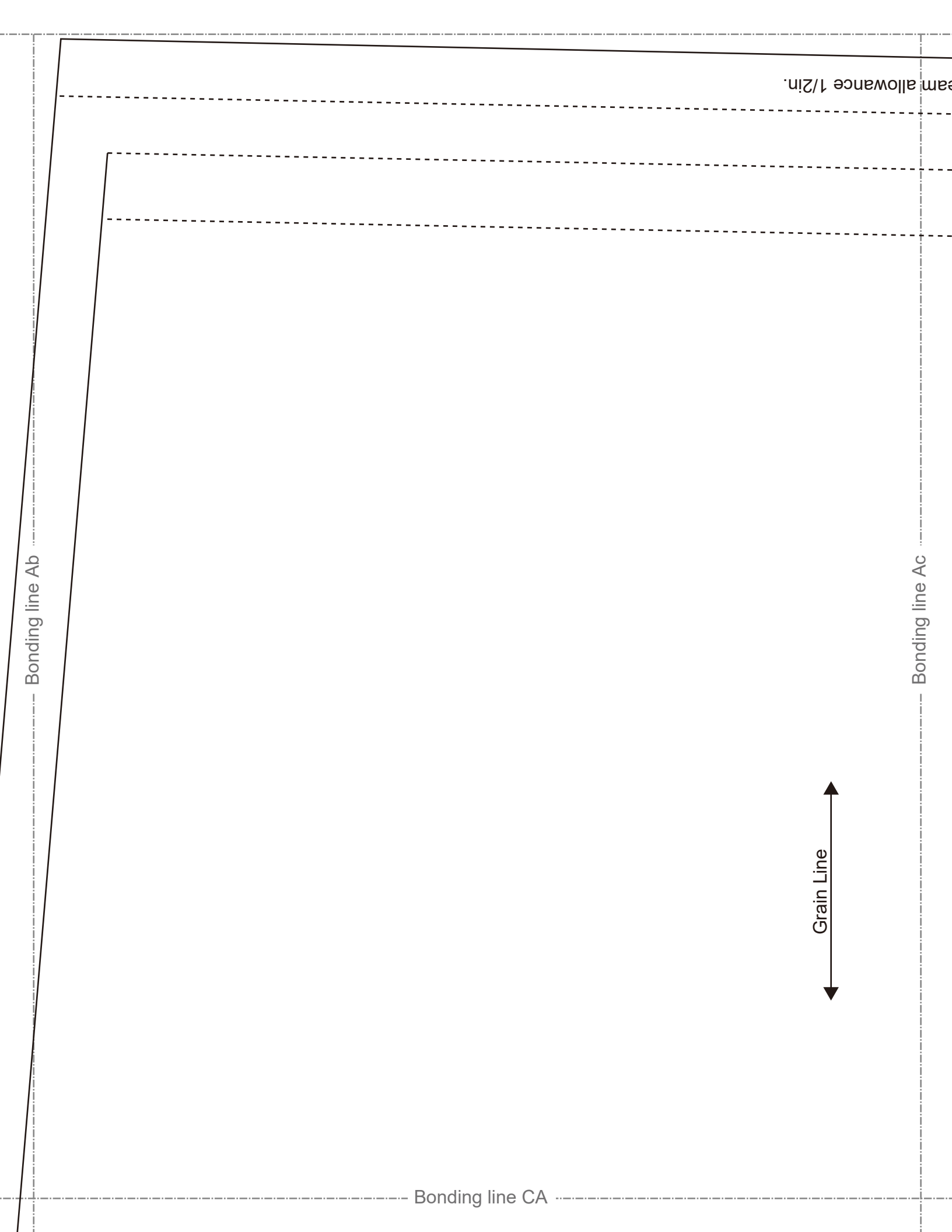

Bonding line CA

Knickerbockers
Back Body
two sheets



Bonding line Bb

Bonding line Bc

Bonding line CB

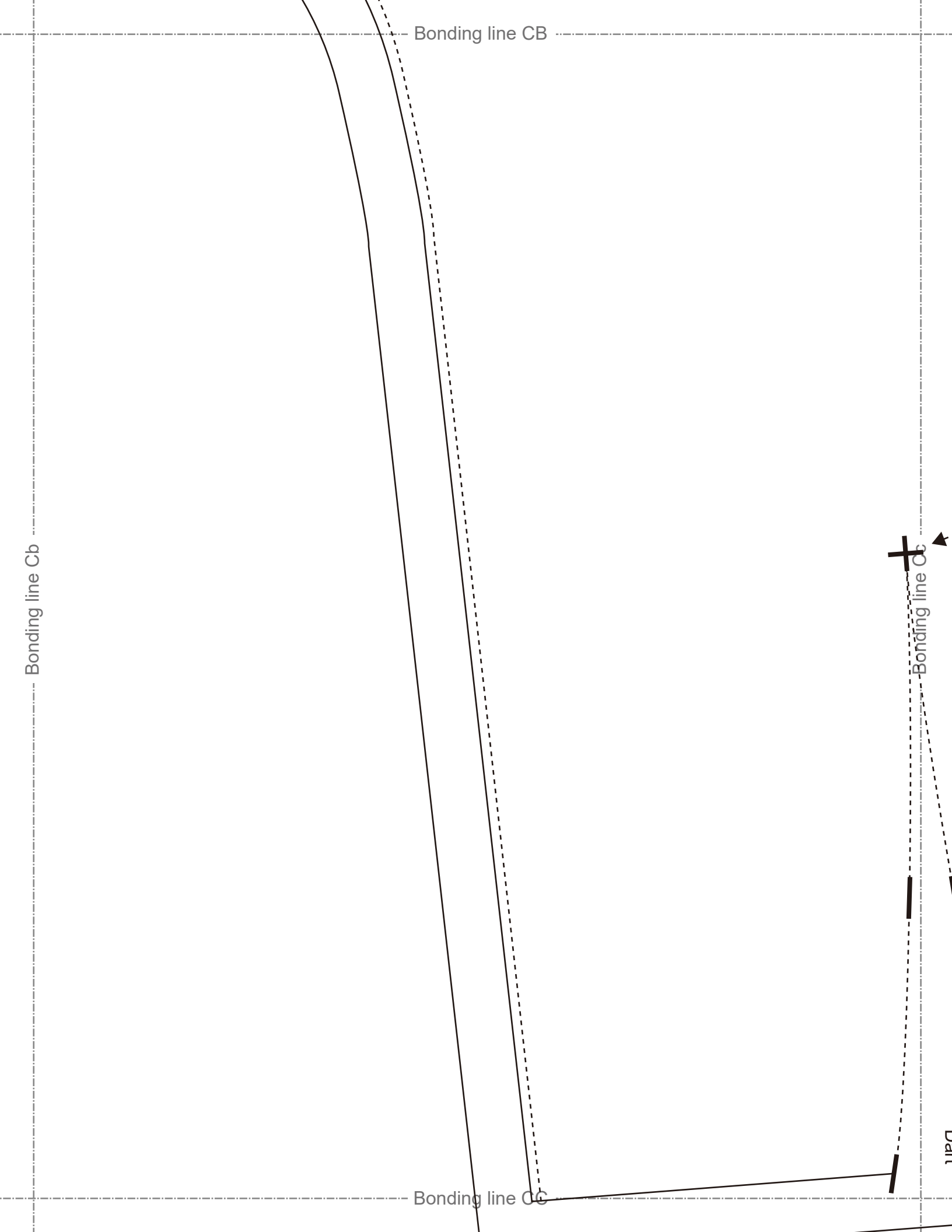

Bonding line CC

Knicker
Extens
one
Fusibl
one



Bonding line Db

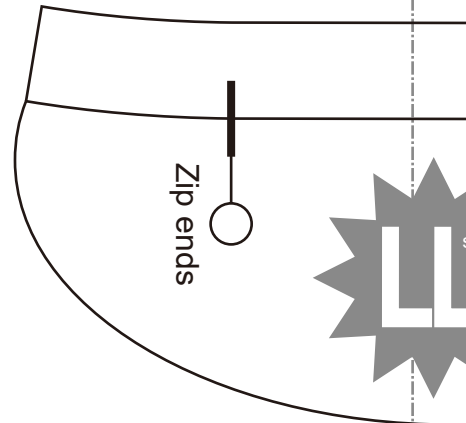

Zip ends

Bonding line Dc

Seam allowance 1/2in.

LADI

Bonding line CD

Seam allo



Bonding line Ac

Bonding line Ad

Bonding line DA



Bonding line Bc

Bonding line DA

Bonding line DB

Bonding line Bd



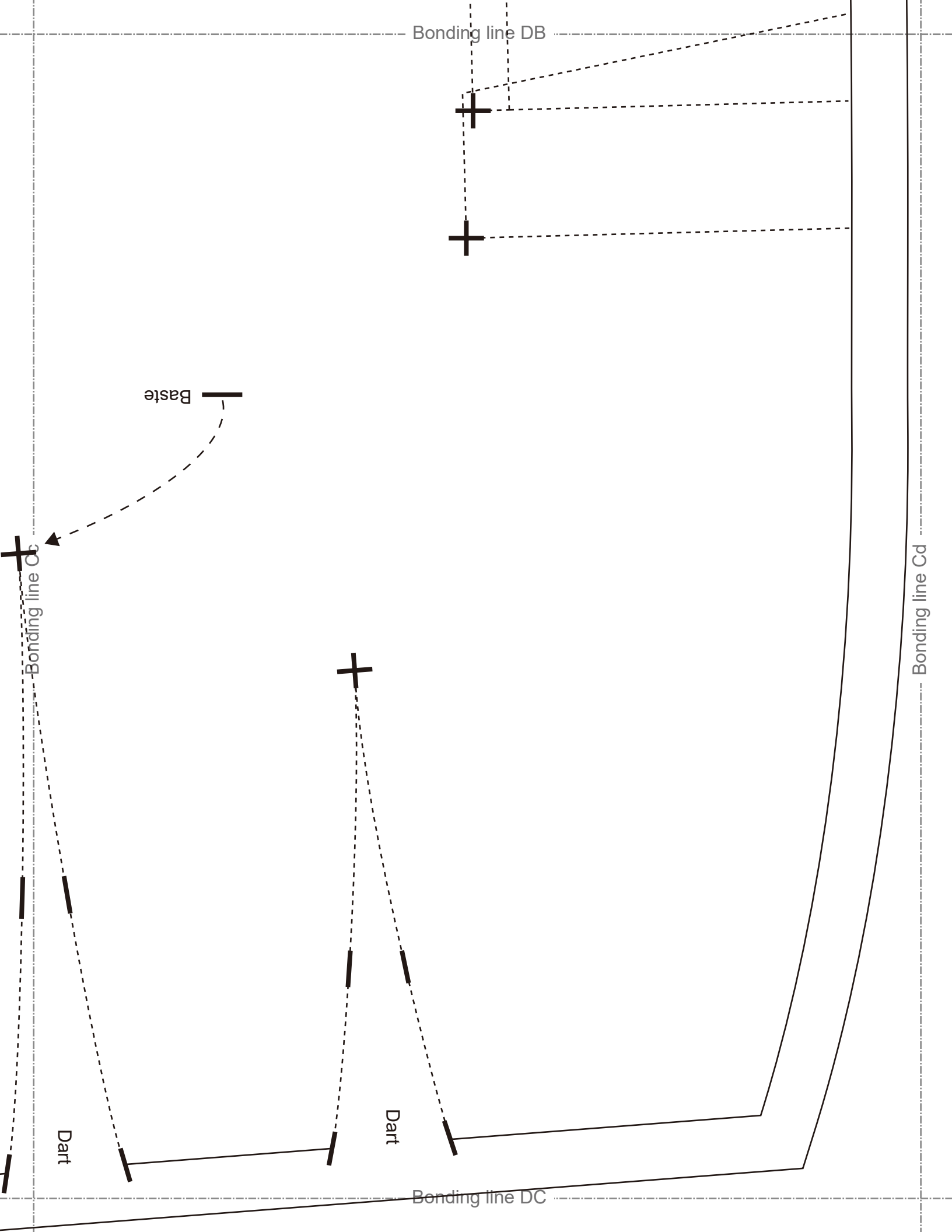

Bonding line DC

Seam allowance 1/2in.

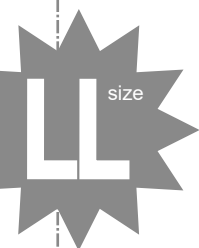

Knickerbockers
Facing
one sheets
Fusible interlining
one sheets

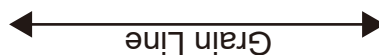

DRCOS

SITE [http://dr-cos.info\(en\)](http://dr-cos.info(en)) [http://dr-cos.com\(jp\)](http://dr-cos.com(jp))
MAIL info@dr-cos.com
Twitter https://twitter.com/@drcos_com
facebook <https://www.facebook.com/drcoscom>

Bonding line Dc

Bonding line Dd



Bonding line DD

Bonding line EC

Bonding line Dd

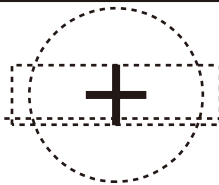

Button position

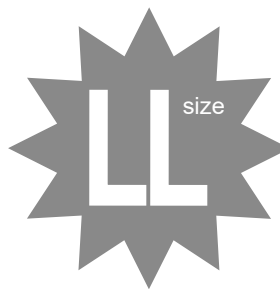

Grain Line

DRCOS

SITE [http://dr-cos.info\(en\)](http://dr-cos.info(en)) [http://dr-cos.com\(jp\)](http://dr-cos.com(jp))
MAIL info@dr-cos.com
Twitter https://twitter.com/drcos_com
facebook <https://www.facebook.com/drcoscom>

Bonding line ED

Bonding line FC

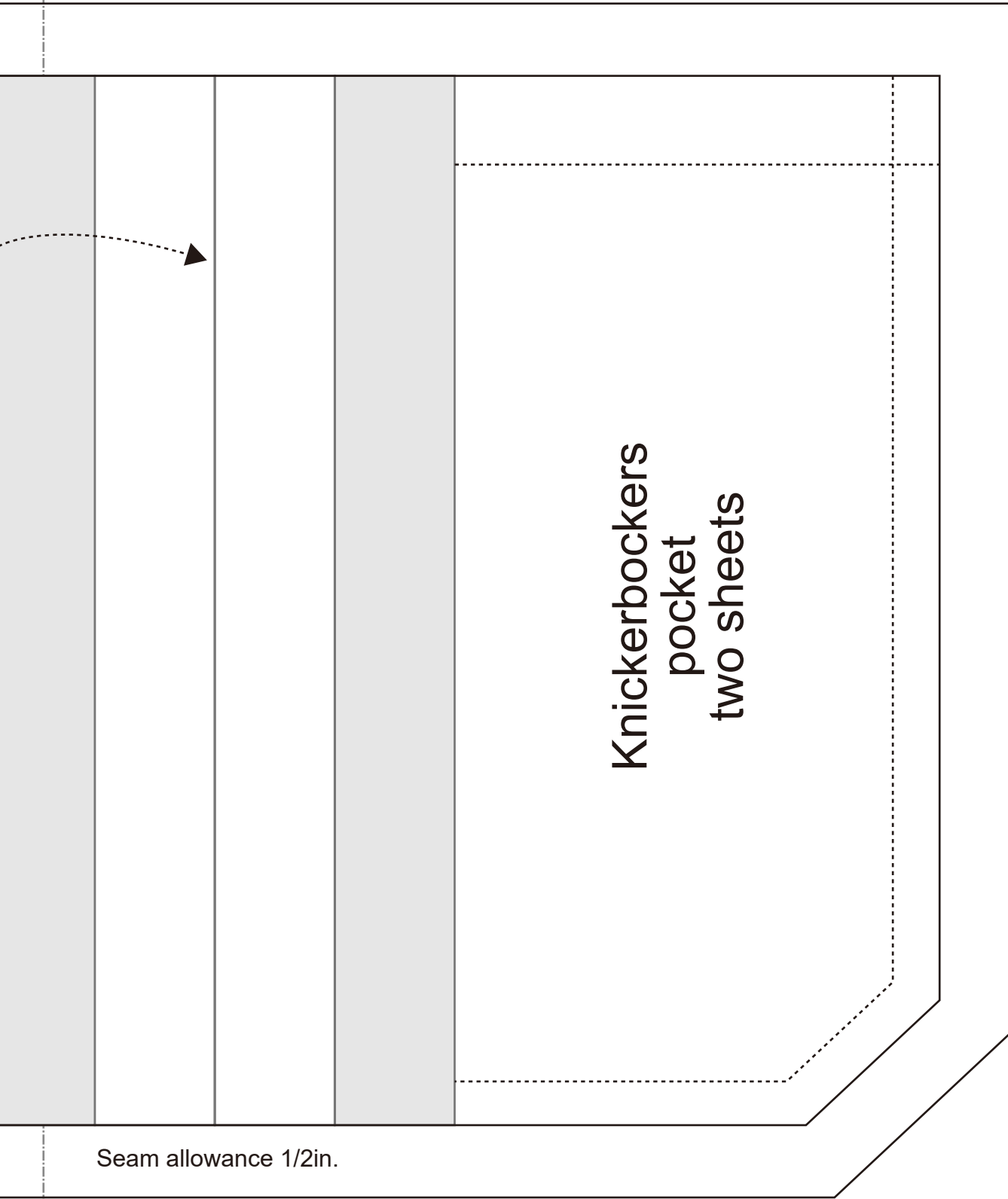

Knickerbockers
pocket
two sheets

Seam allowance 1/2in.

Bonding line FD