

Open end position

Bonding line AA

Bonding line Aa

Bonding line AA

Coad Position



Bonding line Ba

Jinbei
Body
o sheets



Bonding line AB

Bonding line AB



Sleeve position

Bonding line Ca

Bonding line AC

Bonding line AC

facebook <https://www.facebook.com/drcos.com>
Twitter https://twitter.com/drcos_com
MAIL info@drcos.com
SITE [http://drcos.info\(en\)](http://drcos.info(en)) [http://drcos.com\(jp\)](http://drcos.com(jp))

DRCOS

Bonding line Da

Bonding line AD

Bonding line AD



Sleeve position

Bonding line Ea

Bonding line AE

Bonding line AE

Bonding line AF

Bonding line Fa

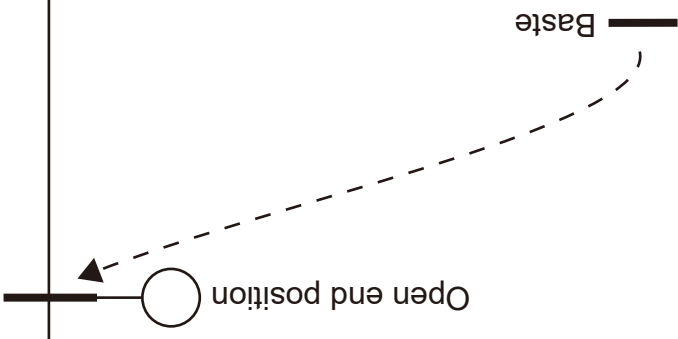

Bonding line AF

Bonding line Ga

Grain Line

LADIES'  size

Seam allowance 1/4in.

Bonding line AG

Seam allowance 1/2in.

Bonding line Aa

Bonding line Ab



Bonding line BA

ar position

Bonding line BA

Bonding line Ba

Jinb
Boc
two sh

LADIE

Bonding line Bb

Bonding line BB

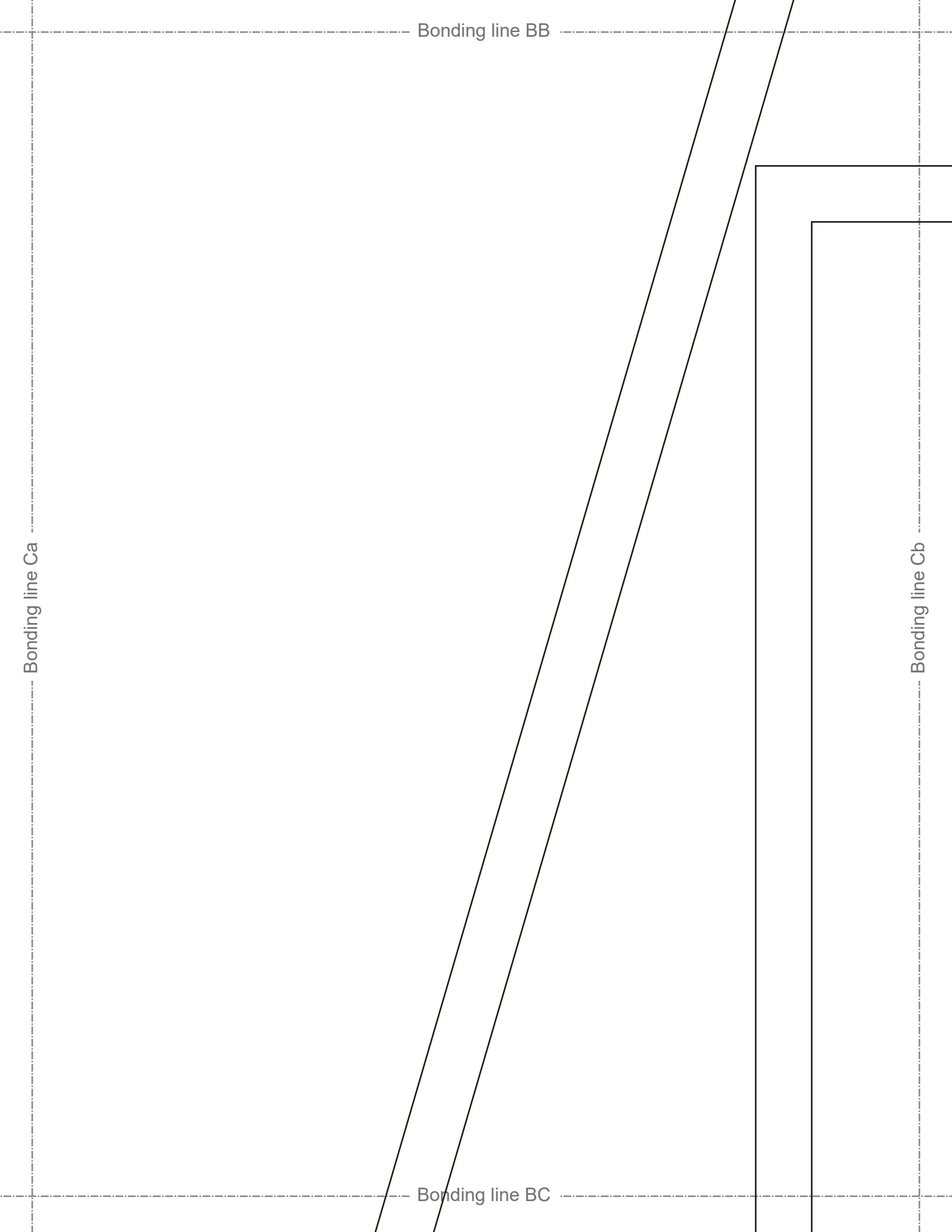

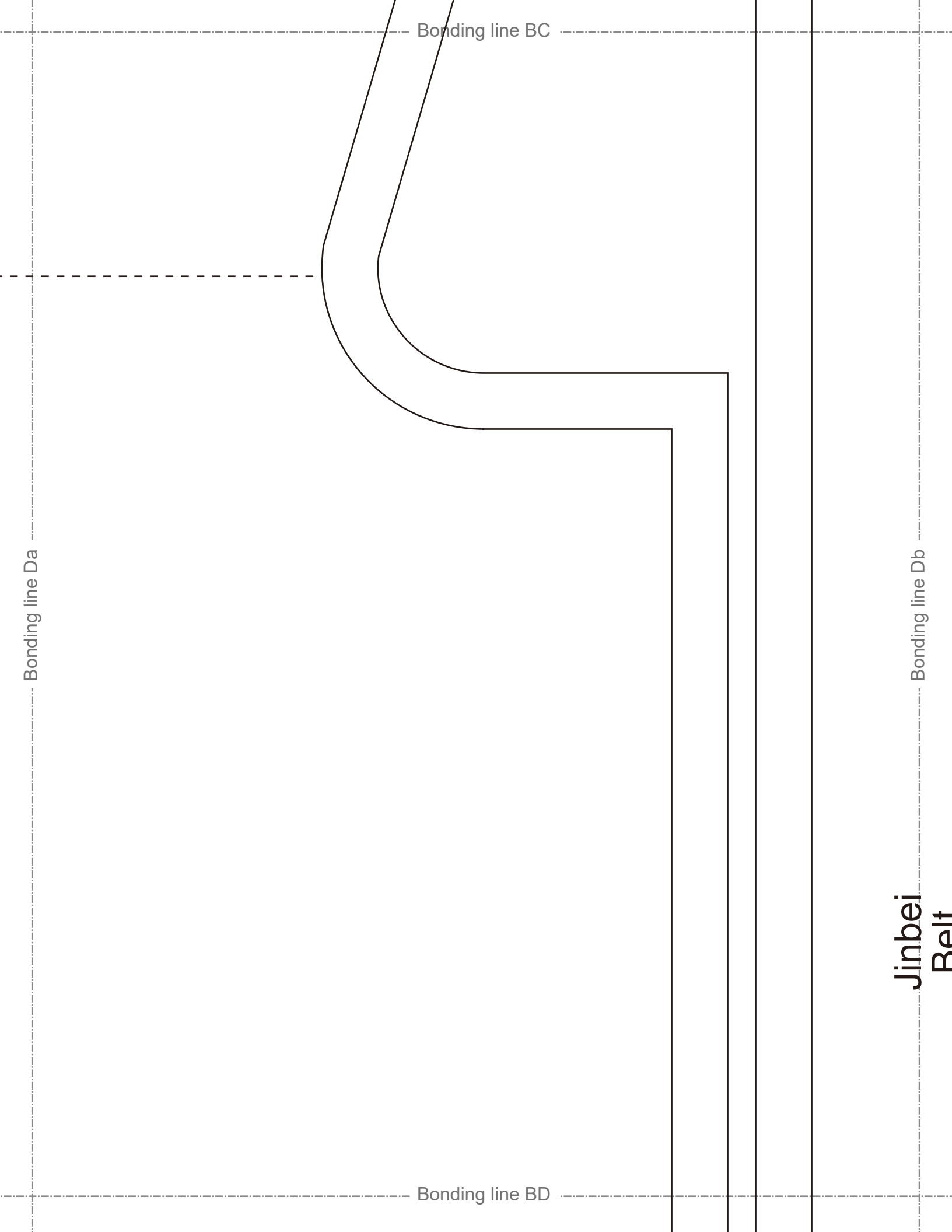

Bonding line BC

Bonding line Da

Bonding line BD

Bonding line Db

**Jinbei
Belt**

Bonding line BD

Bonding line Ea

Bonding line Eb

Bonding line BE



Bonding line BE

Bonding line Fa

Bonding line Fb

Bonding line BF

Bonding line BF

Bonding line Ga

Bonding line Gb

Jinbei
Coad
two sheets



Bonding line BG

Bonding line Ab

Collar position



DRCOS

SITE <http://dr-cos.info/en> <http://dr-cos.com/jp>
MAIL info@dr-cos.com
Twitter https://twitter.com/drcos_com
facebook <https://www.facebook.com/drcoscom>

Coad Position

Bonding line CA

Bonding line Ac

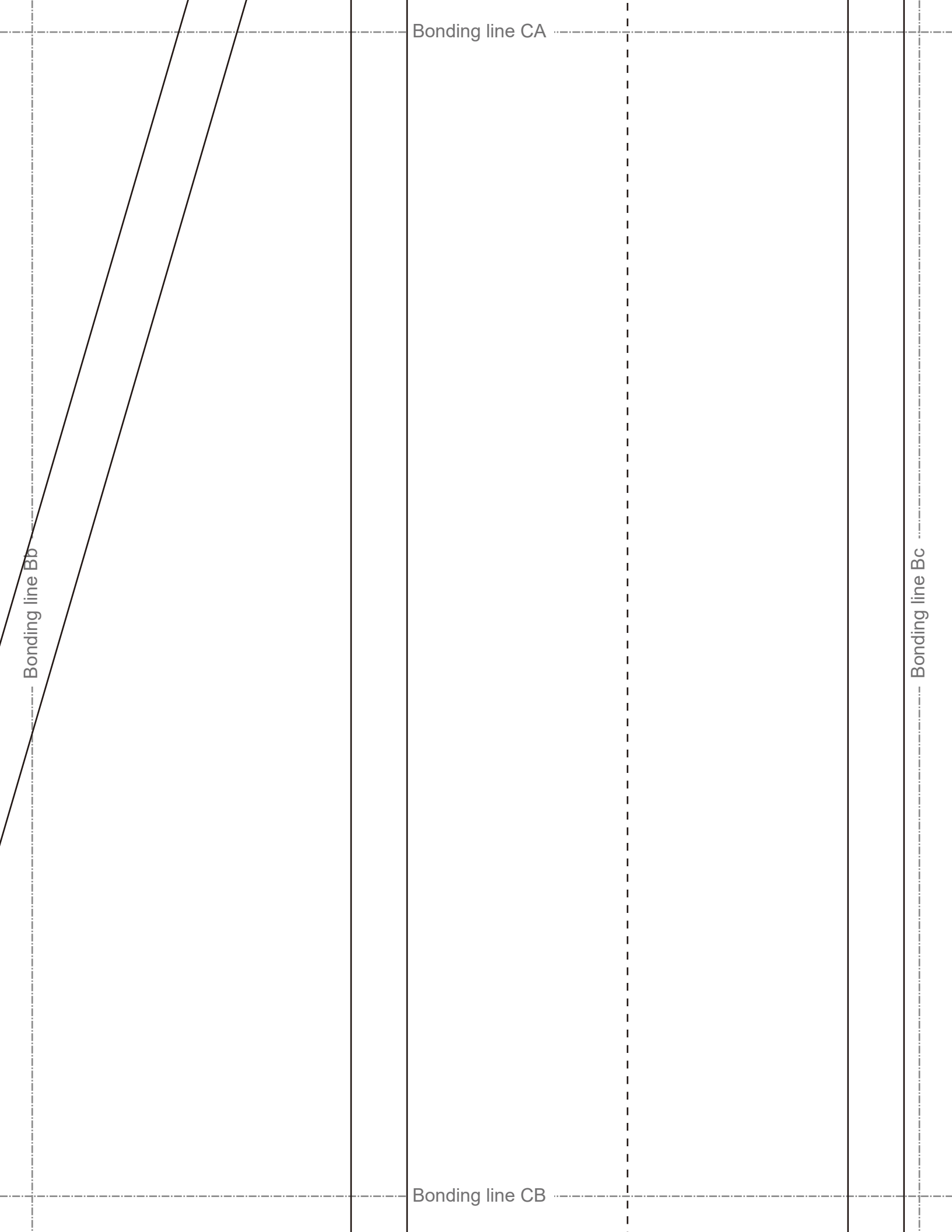

Bonding line CA

Bonding line Bb

Bonding line CB

Bonding line Bc

Bonding line Cb



Bonding line CB

Jinbei
Collar
one sheets

Bonding line CC

Seam allowance 1/2in.

Bonding line Cc

Jinbei

Belt

one sheets

Fusible interlining

one sheets

Bonding line Db

Bonding line CC

Bonding line CD

Bonding line Dc

LADIES'S ^{size} L

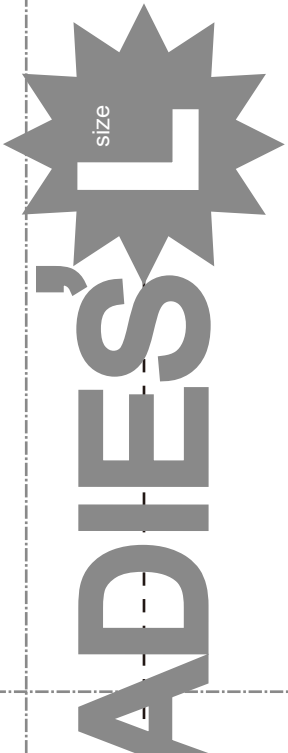

Bonding line Eb

Seam allowance 1/2in.

Bonding line CD



Bonding line CE

Bonding line Ec

LAI

Bonding line Fb



Bonding line CE

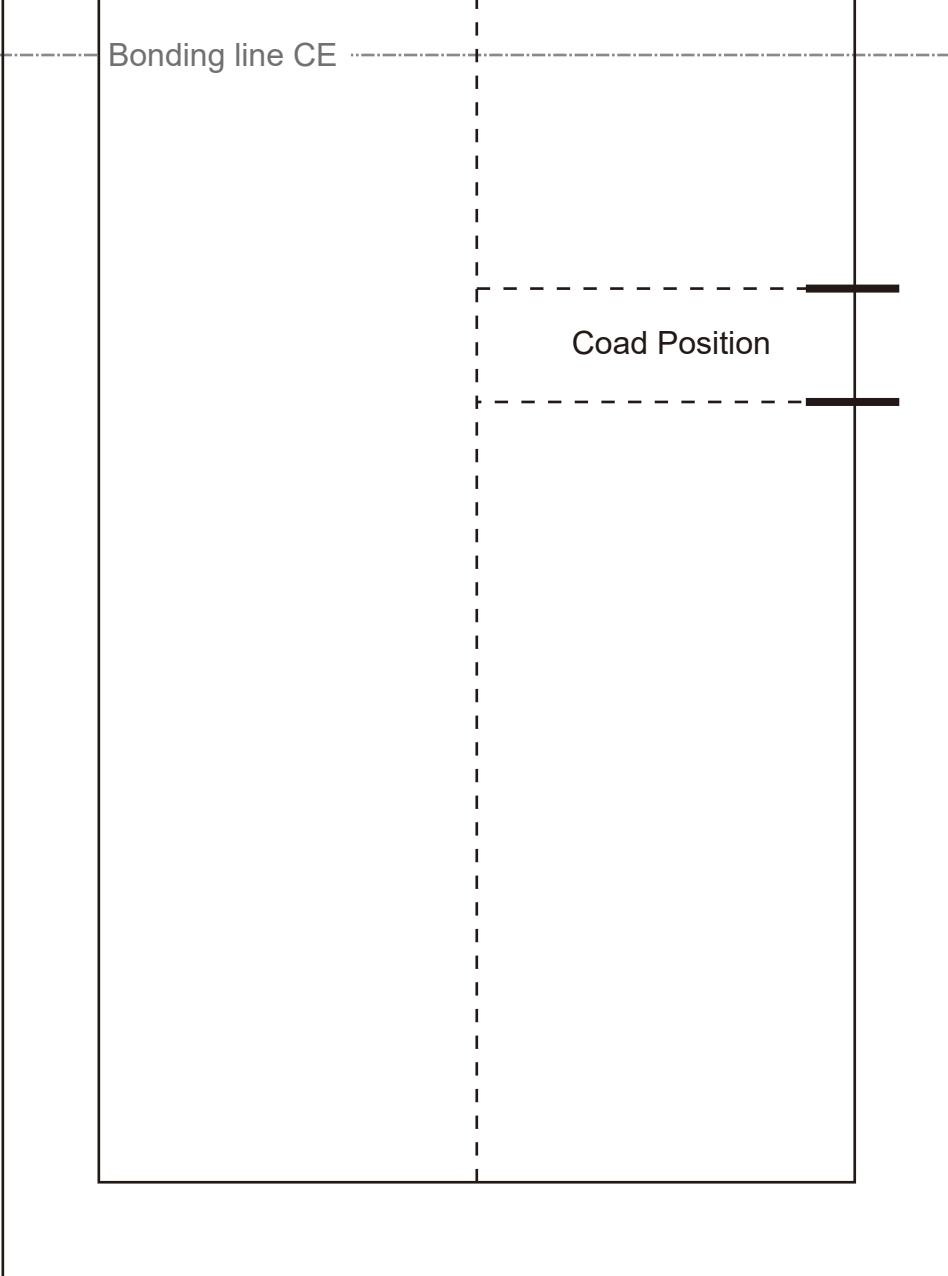

Bonding line Fc

Bonding line CF

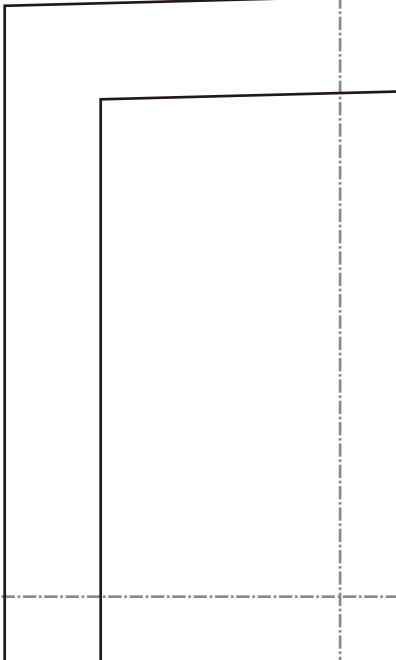

Bonding line Gb



Bonding line CF

Bonding line CG

Bonding line Gc



Bonding line Ac

Bonding line Ad

LADIES

Jinbei
Sleeves
two shee

Bonding line DA

Bonding line DA

Bonding line Bc

Bonding line Bd

Grain Line

Bonding line DB

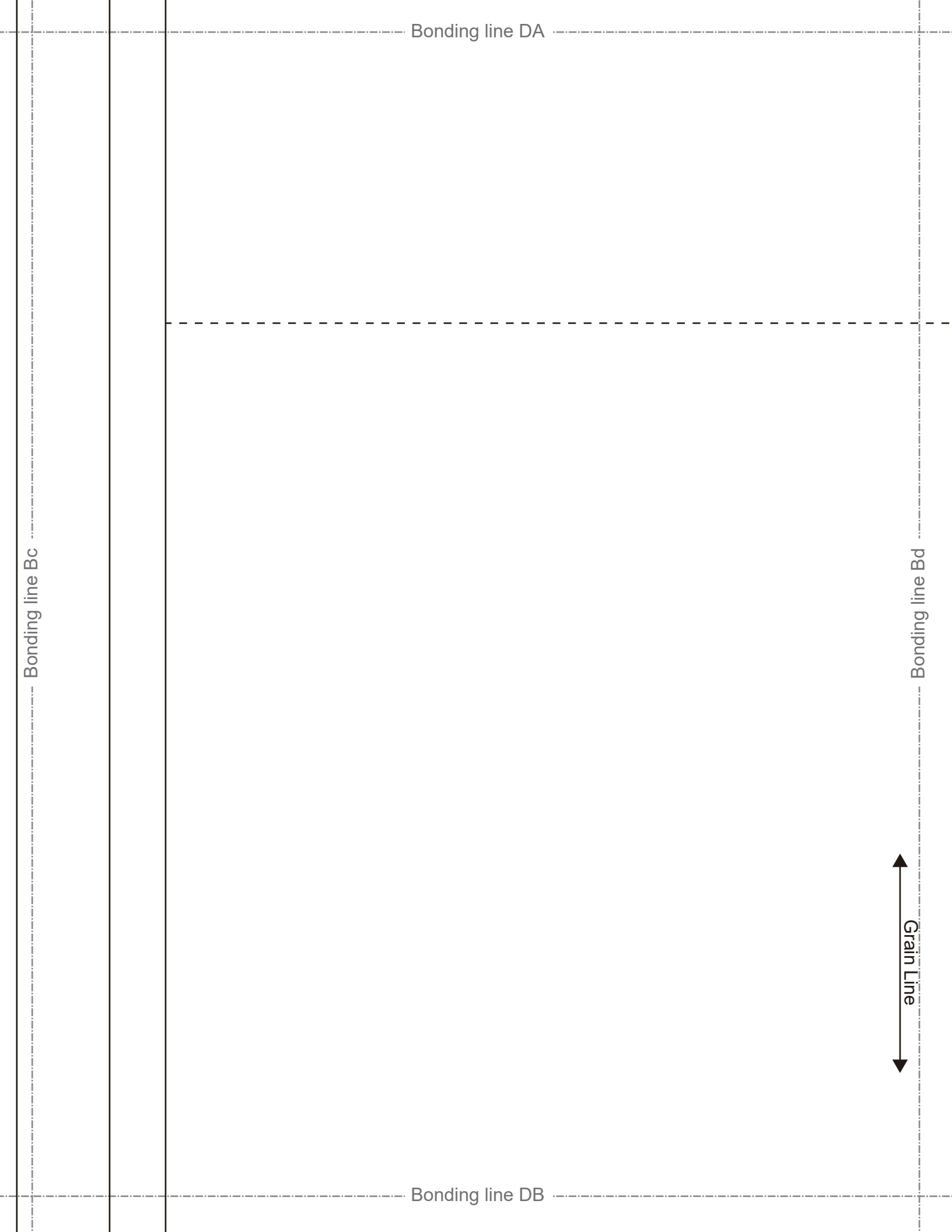

Bonding line DB

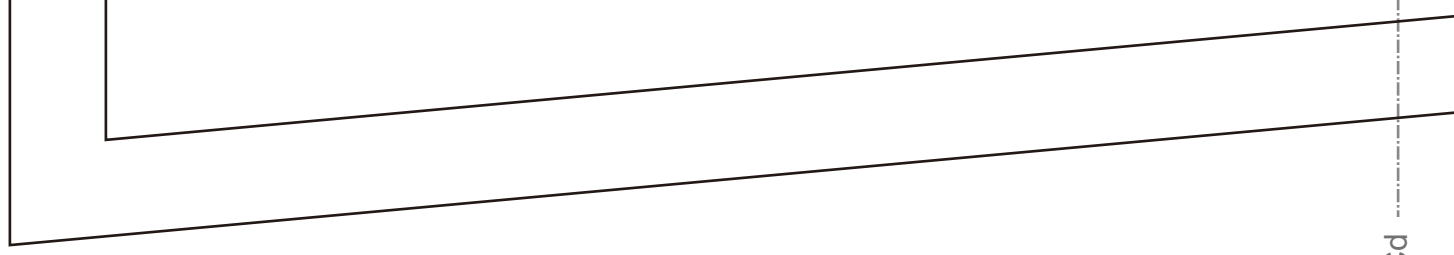

Bonding line Cc

Bonding line Cd

Bonding line DC

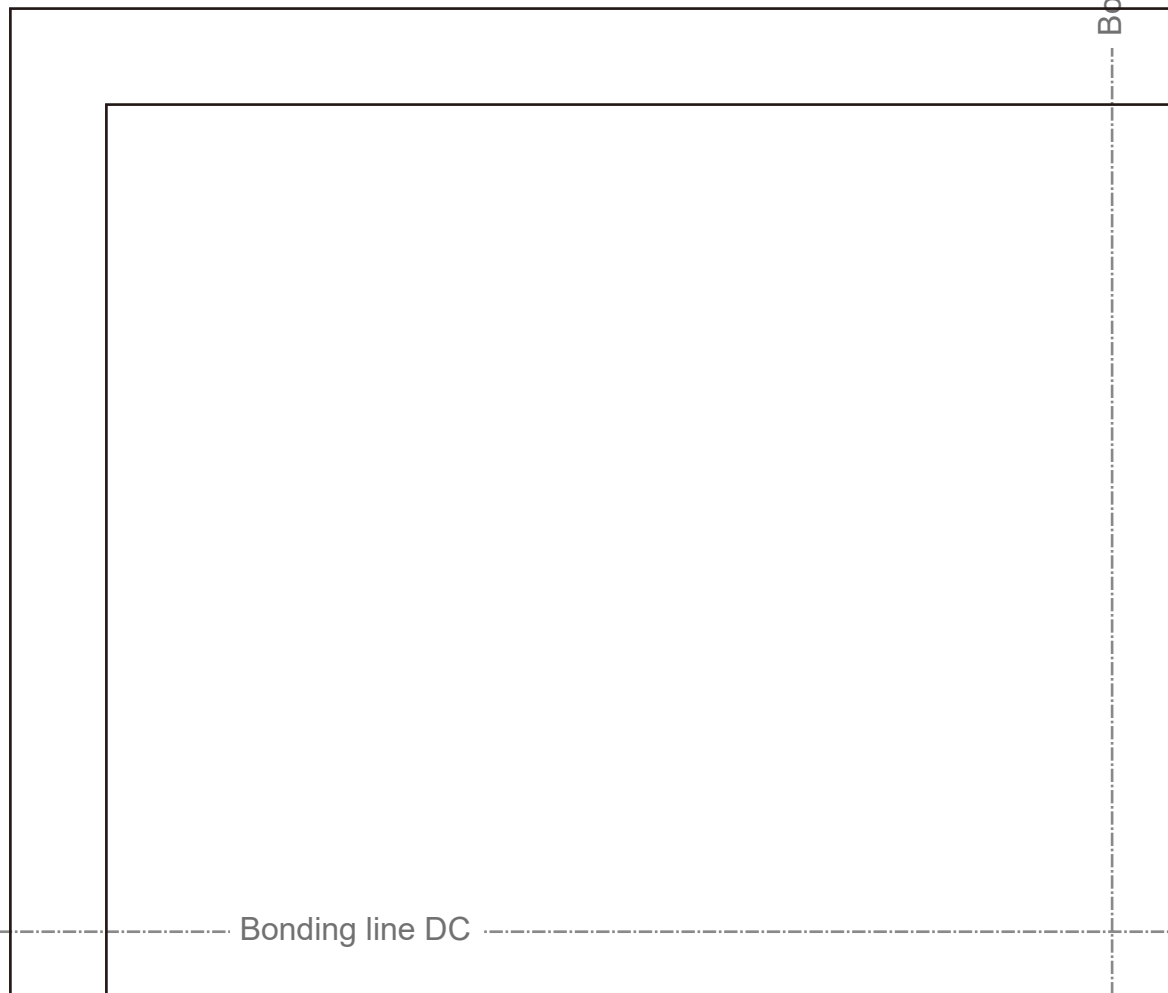

Bonding line DC

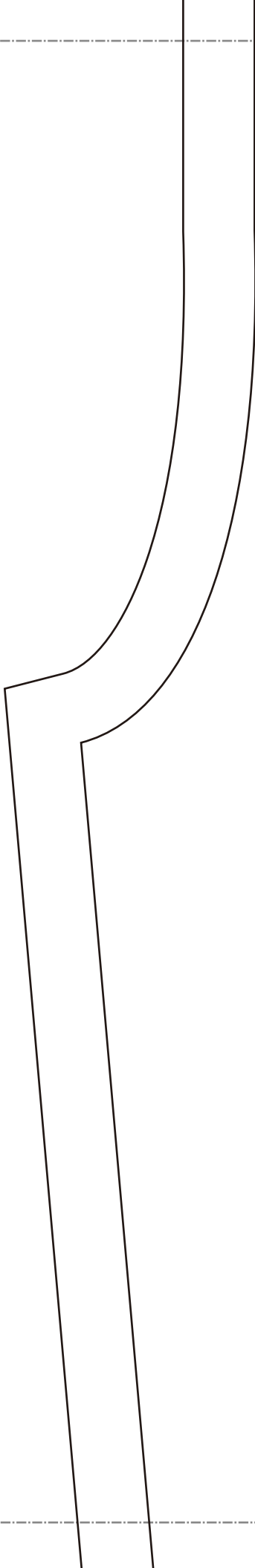

LADIES

Jin
Pants F
two s

Bonding line Dd

Bonding line Dc

Bonding line DD

Bonding line DD

Bonding line Ec

Bonding line Ed

Seam at

Bonding line DE



Bonding line DE

Bonding line Fc

Bonding line Fd

Bonding line DF

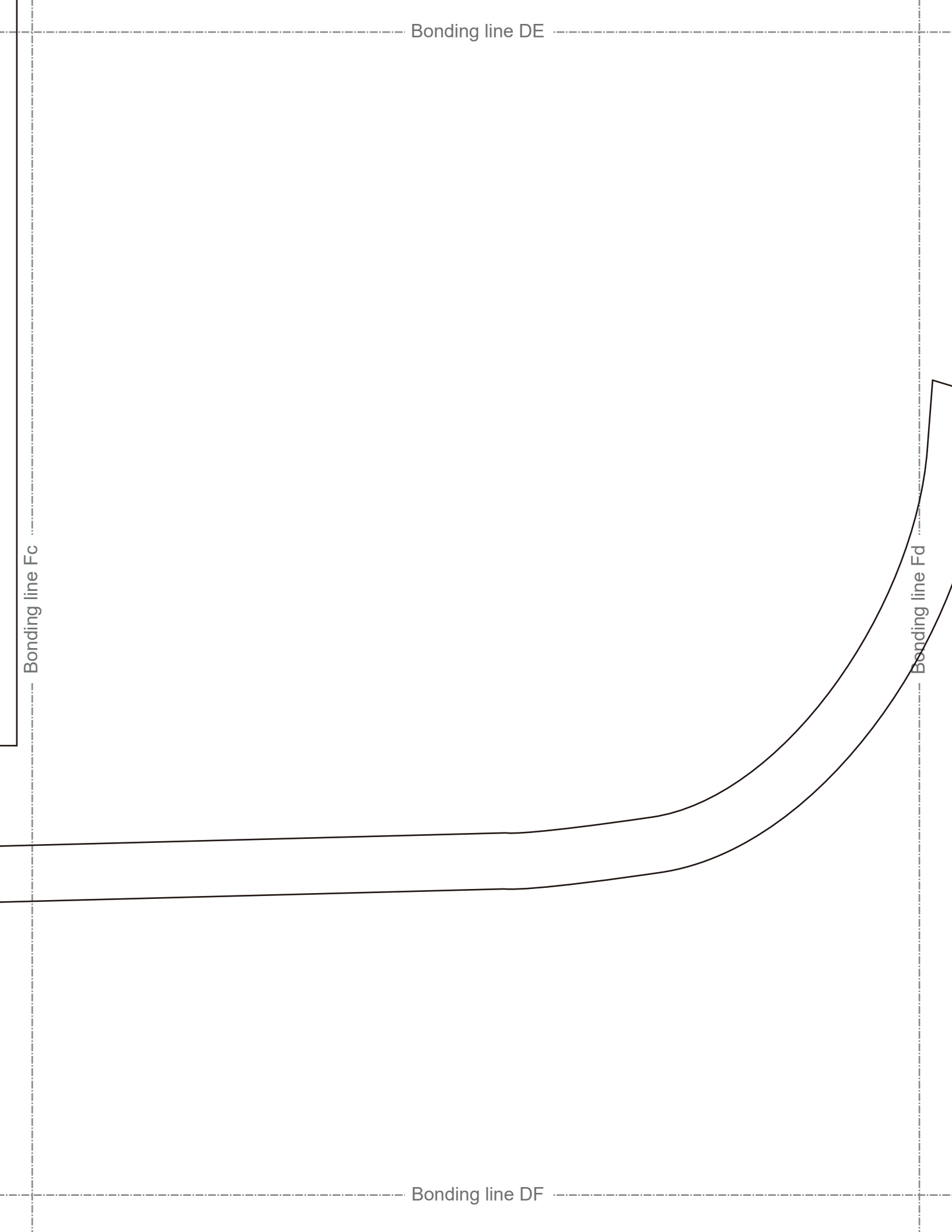

Bonding line Gc

Bonding line DF

LADIES' ^{size} LG

Bonding line Gd

Bonding line DG

Bonding line Ad

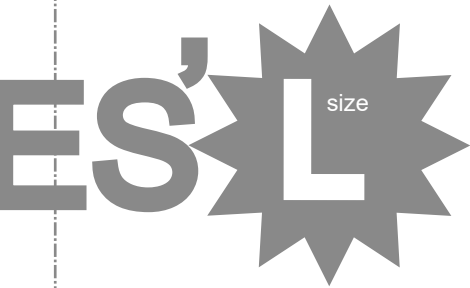

bei
eves
heets

DRCOS
SITE [http://dr-cos.info\(en\)](http://dr-cos.info(en)) [http://dr-cos.com\(jp\)](http://dr-cos.com(jp))
MAIL info@dr-cos.com
Twitter https://twitter.com/drcos_com
facebook <https://www.facebook.com/drcoscom>

Bonding line Ae

Bonding line EA

Bonding line EA

Bonding line Bd



Grain Line

Bonding line EB

Seam allowance 1/2in.

Bonding line Be

Bonding line EB

Bonding line Cd

Bonding line Ce

DRCOS

SITE [http://dr-cos.info\(en\)](http://dr-cos.info(en)) [http://dr-cos.com\(jp\)](http://dr-cos.com(jp))
MAIL info@dr-cos.com
Twitter https://twitter.com/@drcos_com
facebook <https://www.facebook.com/drcoscom>

Bonding line EC

Bonding line EC



Jinbei
 ts Front Body
 wo sheets

Bonding line Dd

Bonding line De

Bonding line ED



Bonding line ED



Grain Line

Bonding line Ed

Bonding line Ee

Seam allowance 1/2in.

Bonding line EE

Bonding line EE

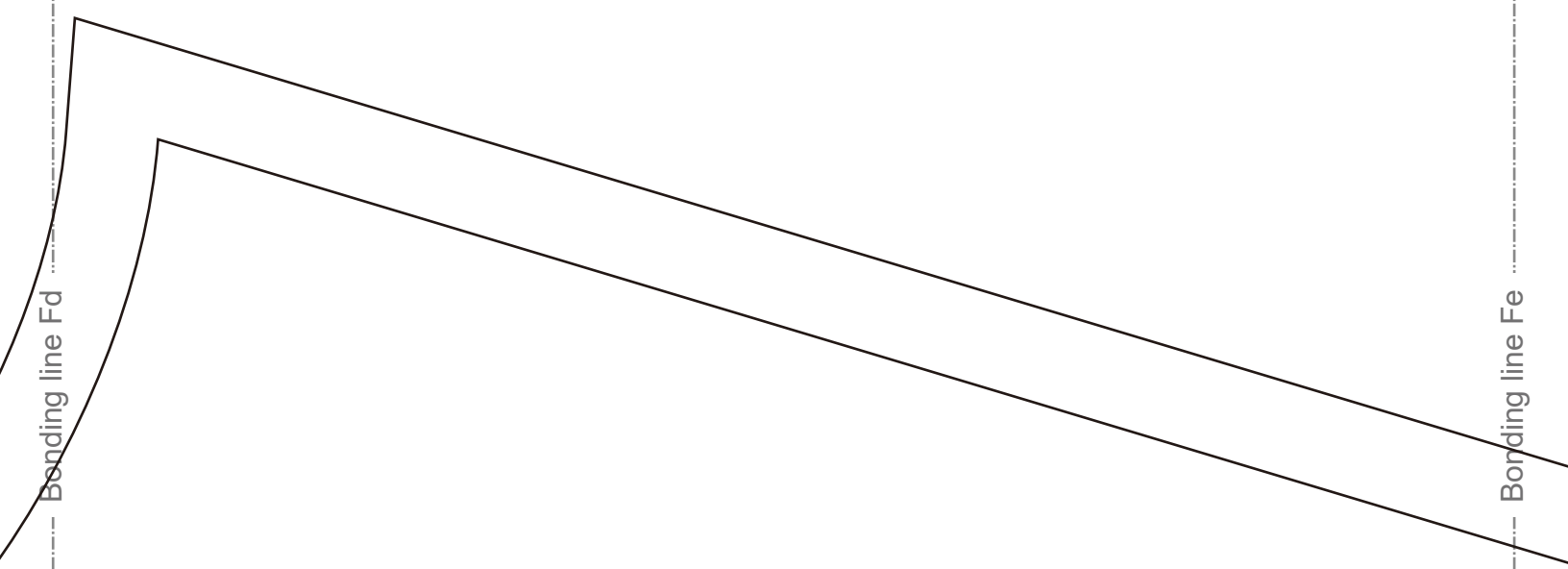

Bonding line Fd

Bonding line Fe

Bonding line EF



**Jinbei
Pants Back Body
two sheets**

Bonding line Gd

Bonding line EF

← Grain Line

Bonding line Ge

Bonding line EG

Bonding line FE

Bonding line Fe

Bonding line Ff

Bonding line FF

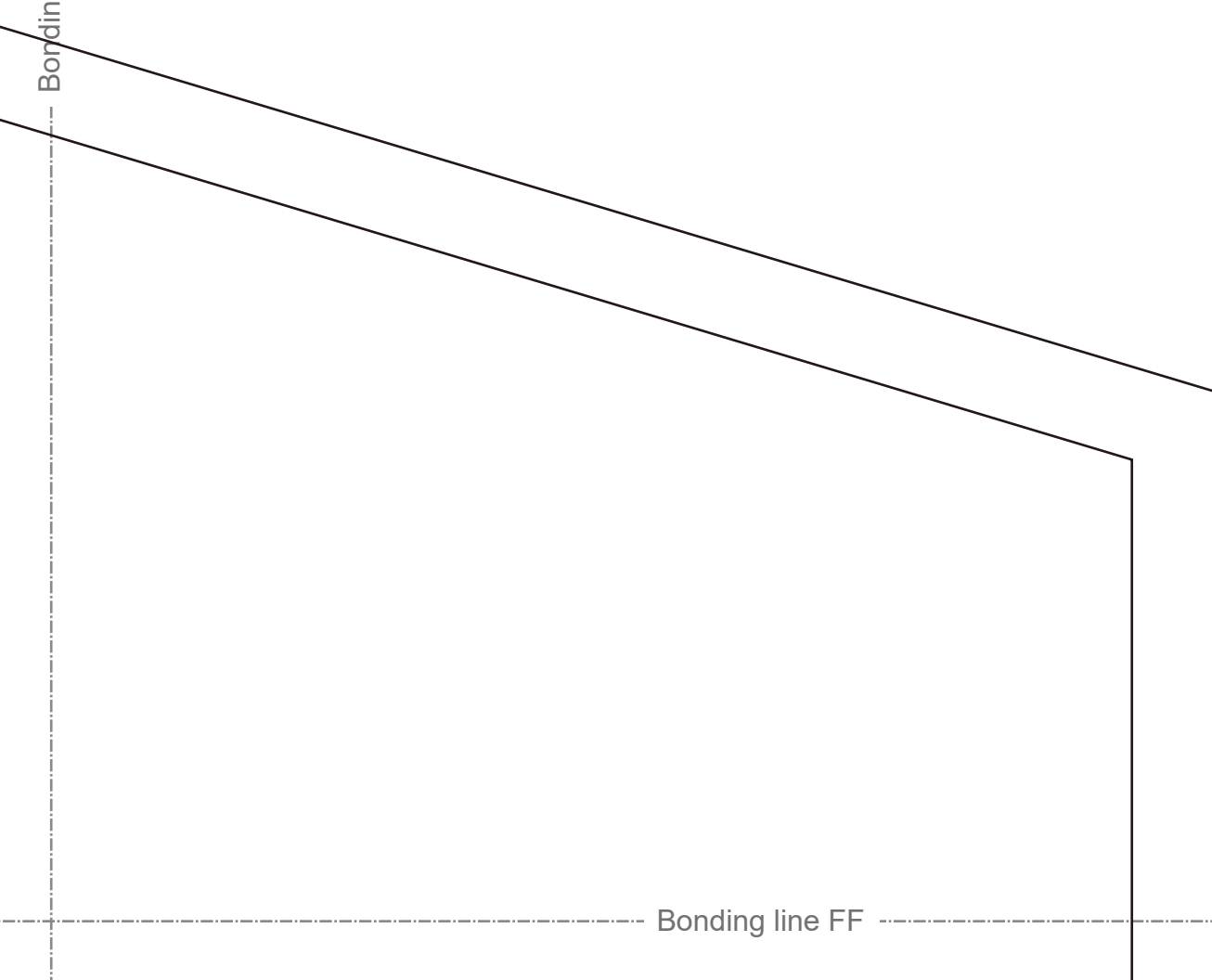

Bonding line FF

n Line →

Bonding line Ge

Seam allowance 1/2in.

Bonding line Gf

Bonding line FG