

[Home](#)

[Back to Tshirt page](#)

www.drops.com
-cos.com(pdf)

SC

Bonding line Aa

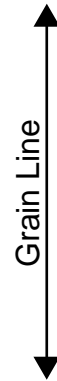

Bonding line AA

Bonding line AA



T-shirt
Back Body
one sheets

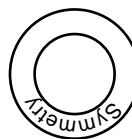

MEN'S
1
size

Bonding line Ba

Bonding line AB

Bonding line AB

Bonding line Ca

Bonding line AC

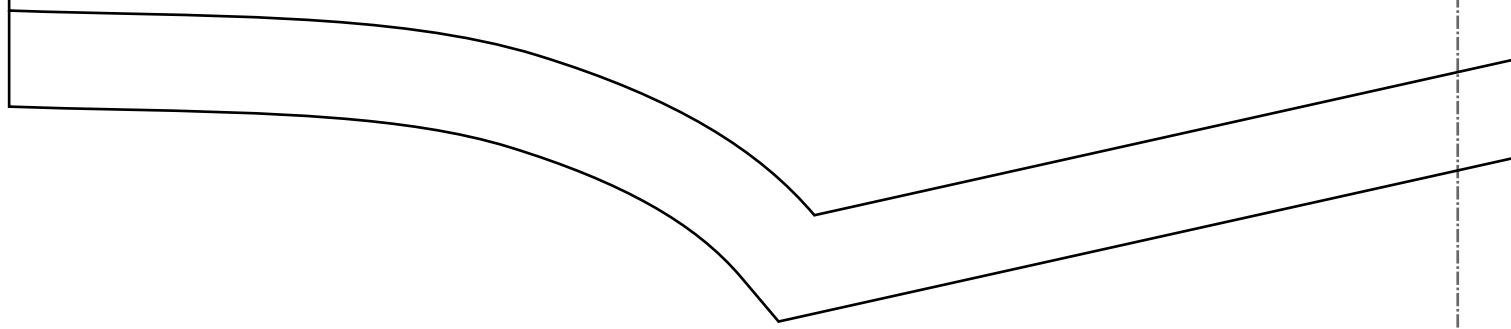

Bonding line Aa

DRCOS
SITE <http://dr-cos.info/en> <http://dr-cos.com/jp>
MAIL info@dr-cos.com
Twitter https://twitter.com/dr-cos_com
Facebook <https://www.facebook.com/drcoscom>

Seam allowance 1/2in.

Bonding line BA

Seam allowance 1

DRCOS
SITE <http://dr-cos.info/en> <http://dr-cos.com/jp>
MAIL info@dr-cos.com
Twitter https://twitter.com/dr-cos_com
Facebook <https://www.facebook.com/drcoscom>

Bonding line Ab

Bonding line Ba

Seam

Bonding line BA

Advance 1/2in.

Bonding line Bb

Symmetry

Grain Line

Bonding line BB

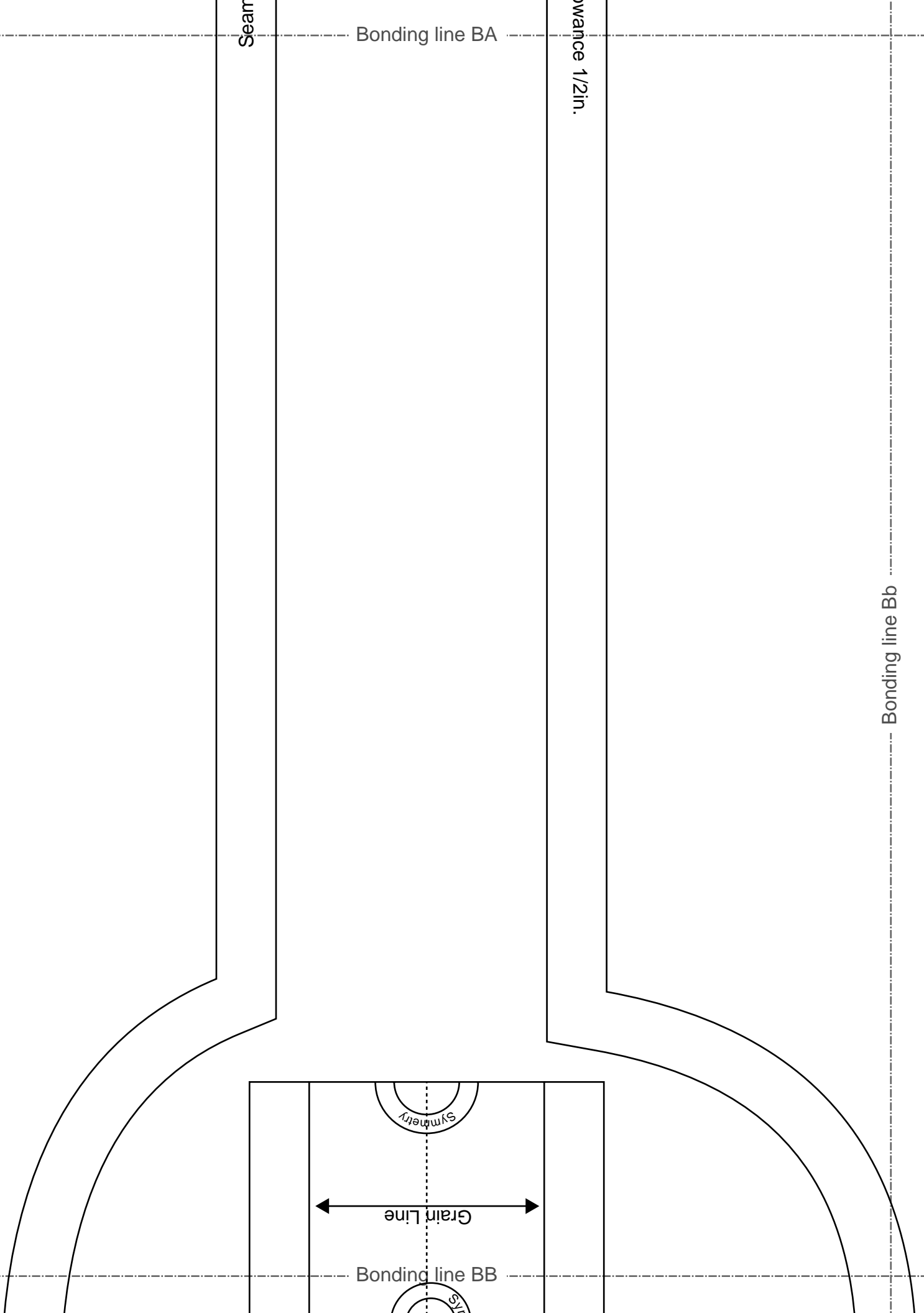

Bonding line BB

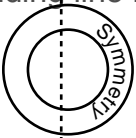

Tshirt
Neck
one sheets

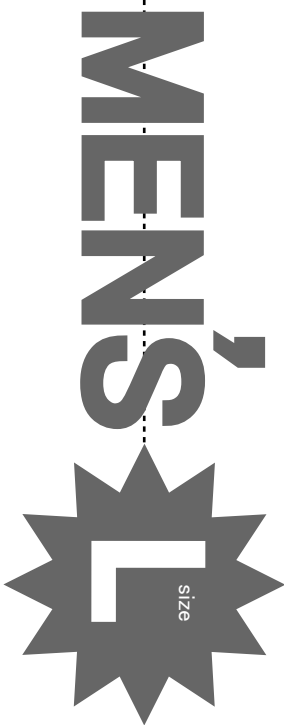

Seam allowance 1/2in.

DRCOS
SITE <http://dr-cos.info/en> [http://dr-cos.com\(lp\)](http://dr-cos.com(lp))
MAIL info@dr-cos.com
Twitter <https://twitter.com/dr-cos>
facebook <https://www.facebook.com/drcos.com>

Bonding line Ca

Bonding line Cb

Bonding line BC

DRC

Bonding line BC

DRC

SITE <http://dr-cos.info/en/>
MAIL info@dr-cos.com
Twitter <https://twitter.com/DRCOS>
facebook <https://www.facebook.com/DRCOS>

Bonding line Da

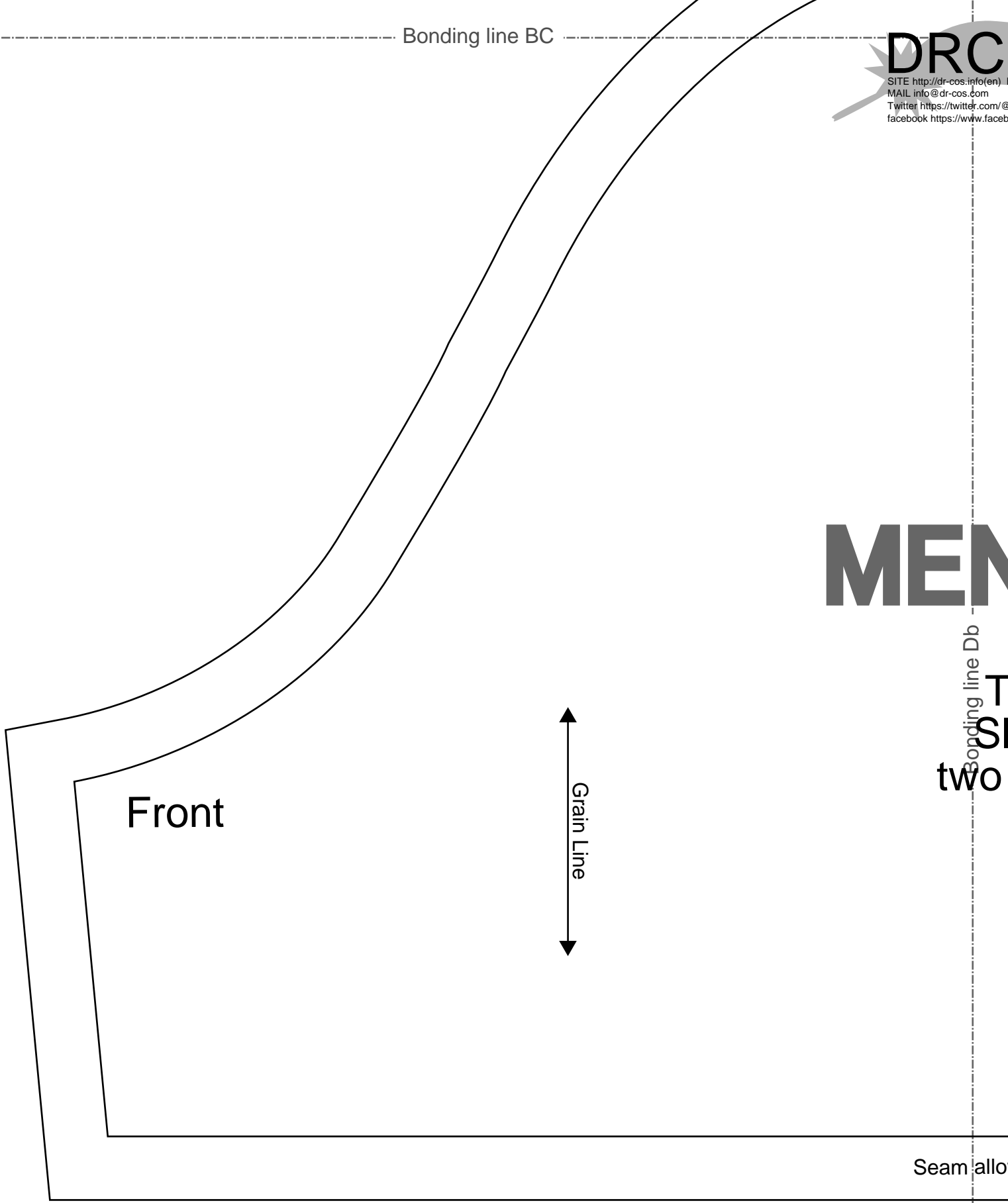

Front

Grain Line

Seam allo

MEN

Bonding line Db
T
S
two

Bonding line Ab

Bonding line Ac

Grain Line



Bonding line CA

Bonding line CA

Bonding line Bb

MEN'S **T**
size

Tshirt
Front Body
one sheets

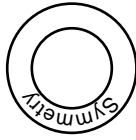

Bonding line Bc

Bonding line CB

Bonding line CB

Bonding line Cb

Bonding line Cc

Bonding line CC

RCOS

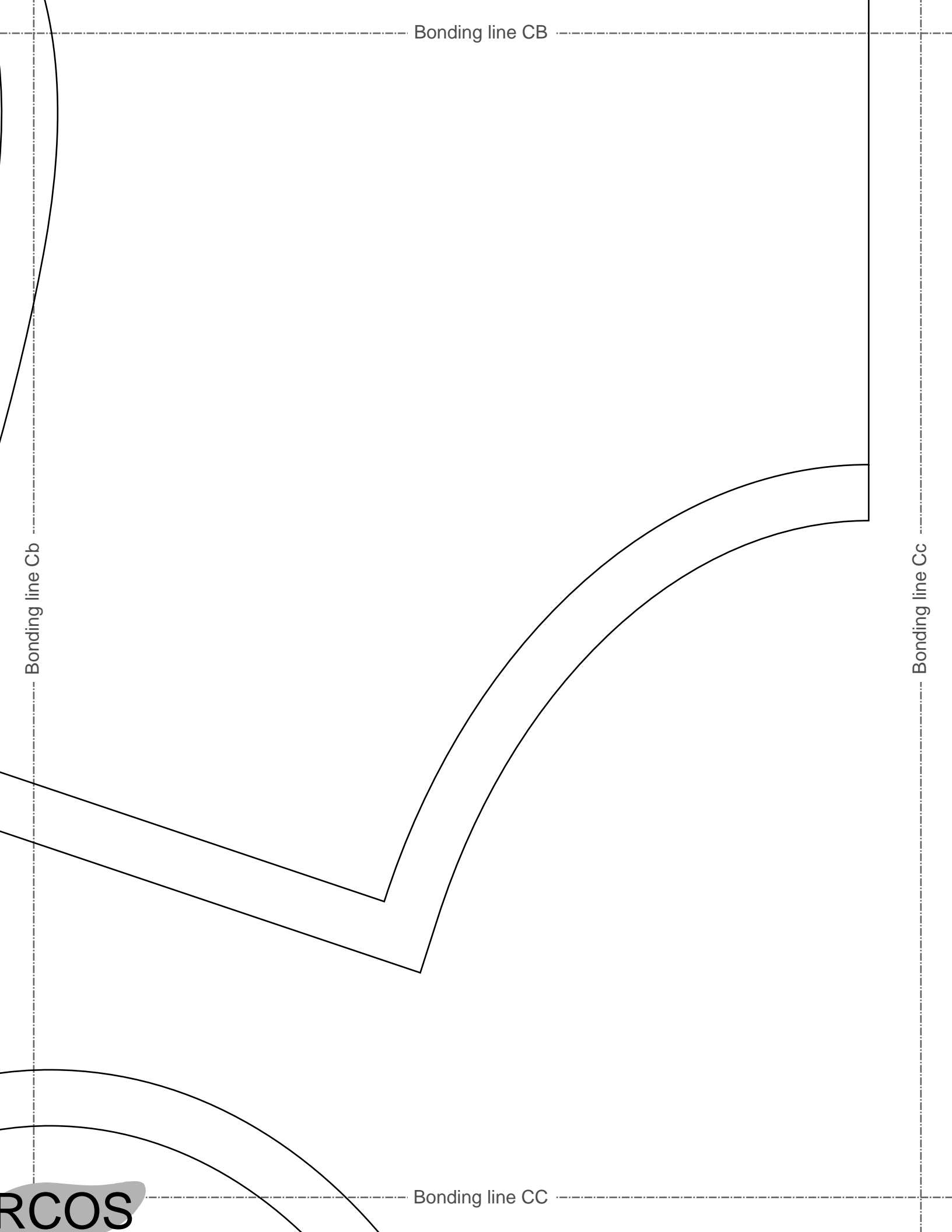

RCOS

[/dr-cos.info/en](http://dr-cos.info/en) <http://dr-cos.com/jp>
@dr-cos.com
@dr-cos.com
@dr-cos.com
<https://www.facebook.com/drcoscom>

Bonding line CC

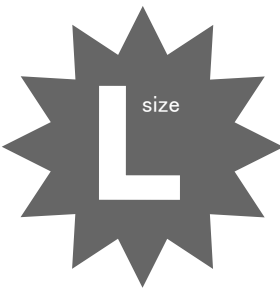
WOMEN'S  size

Bonding line Db
T-shirt
Sleeve
two sheets

Back

Bonding line Dc

hem allowance 1/2in.