

[Home](#)  
[Back to Shrinemaiden page](#)

Seam allowance 1/2in.

Bonding line Aa



Bonding line AA

Bonding line AA



Bonding line Ba

Bonding line AB

at body side

Bonding line AB

Front bo

Shrine Maiden(Miko)  
Body  
two sheets

Bonding line Ca



Bonding line AC

Bonding line AC

Sewing stop position

Fold and sew

Sleeve sewing stop

Bonding line AD

Bonding line Da

st position

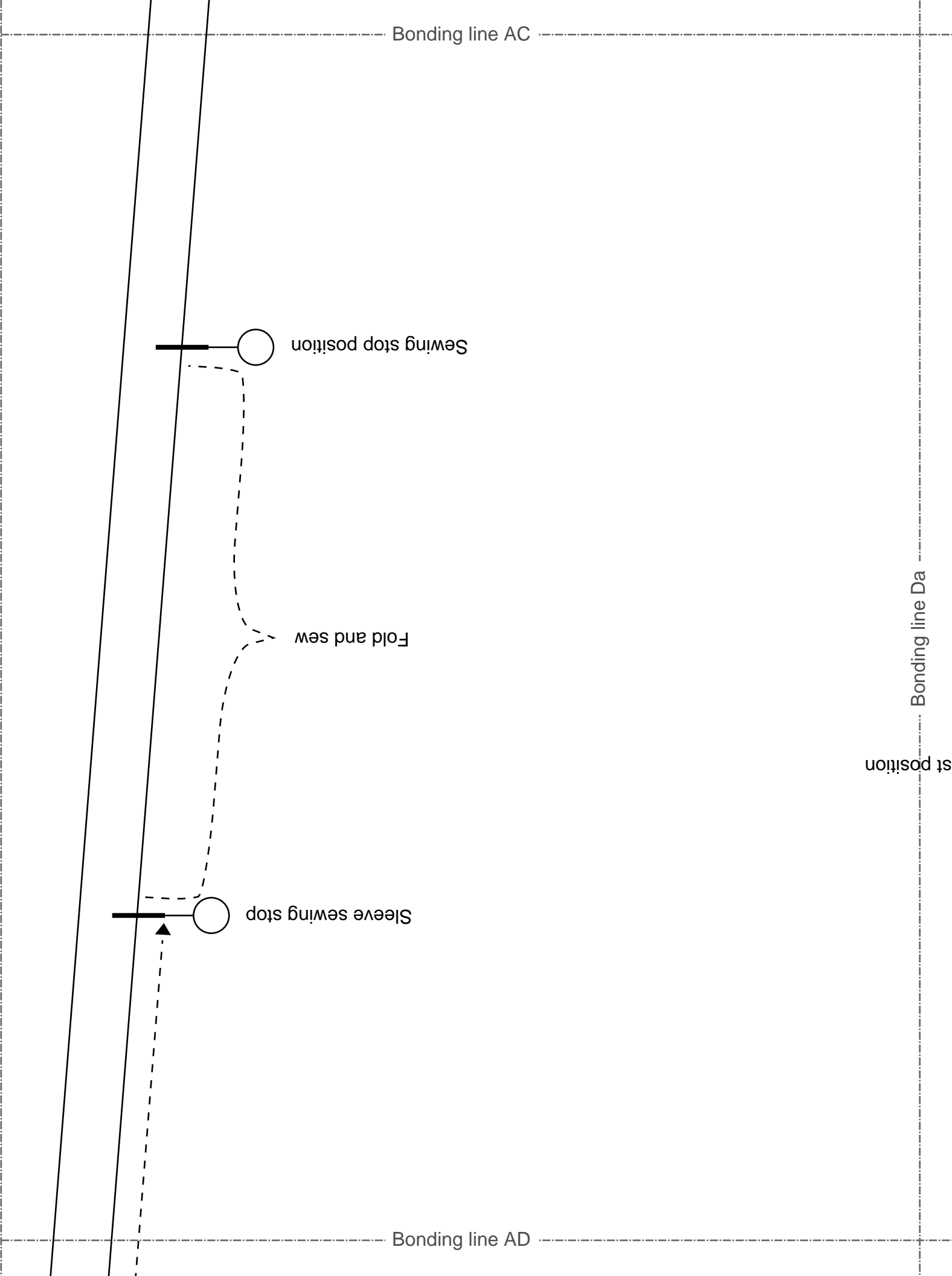

Bonding line AD

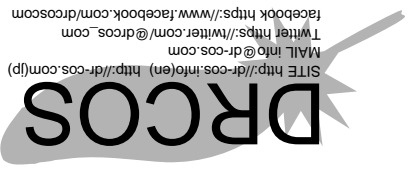

SITE <http://dr-cos.info/en> <http://dr-cos.com/jp>  
MAIL [info@dr-cos.com](mailto:info@dr-cos.com)  
Twitter [https://twitter.com/dr-cos\\_com](https://twitter.com/dr-cos_com)  
Facebook <https://www.facebook.com/drcoscom>

Bonding line Ea

Bonding line AE

Bonding line AE

Sleeve sewing stop

Fold and sew

Sewing stop position

Bonding line AF

Bonding line Fa

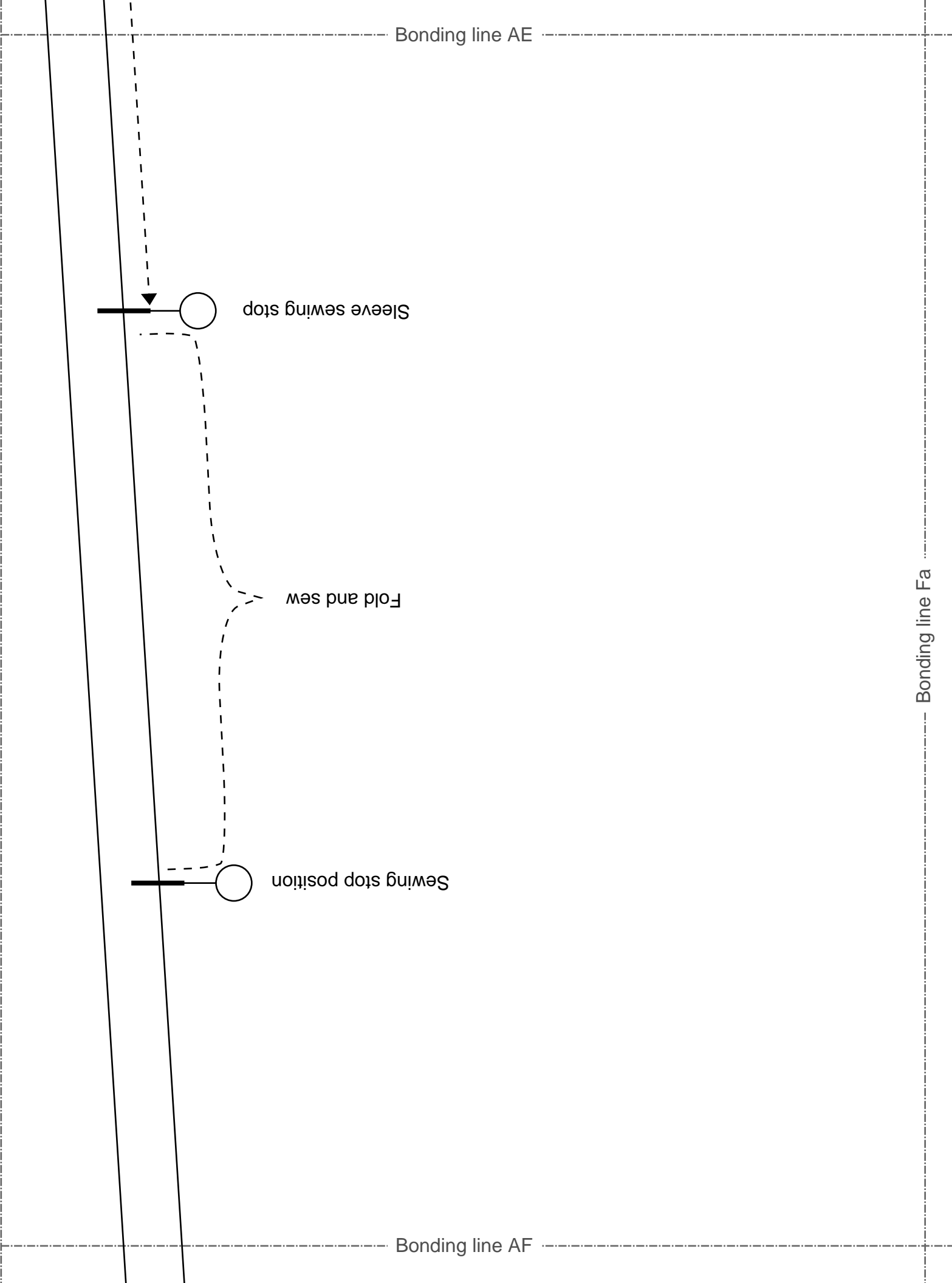

Bonding line AF

Bonding line AG

Bonding line Ga

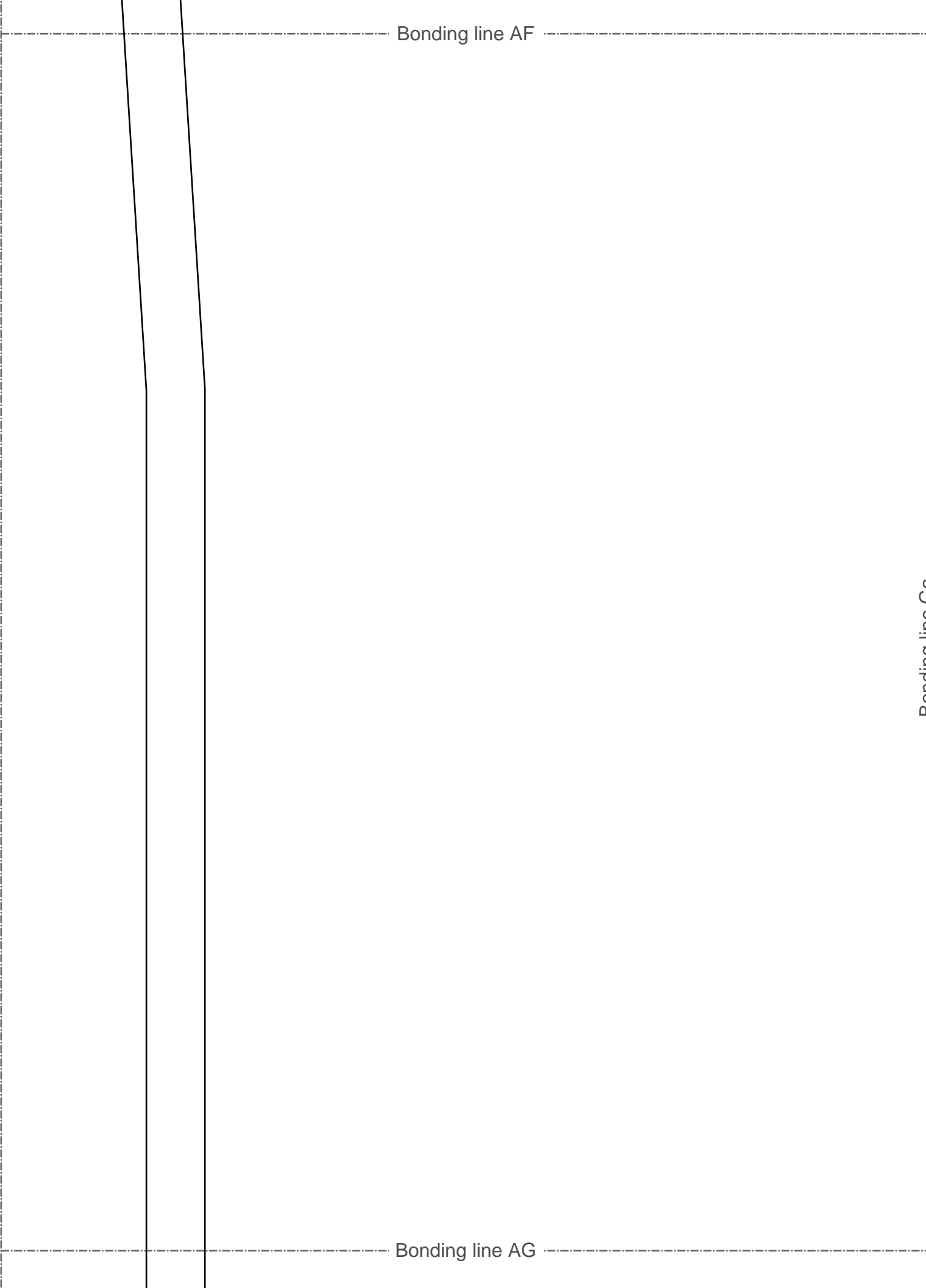

Bonding line AG

**Back body side**

Bonding line Ha

Bonding line AH



Gr



Bonding line AH

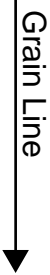

Bonding line la

Seam allowance 1/2in.

Bonding line Aa

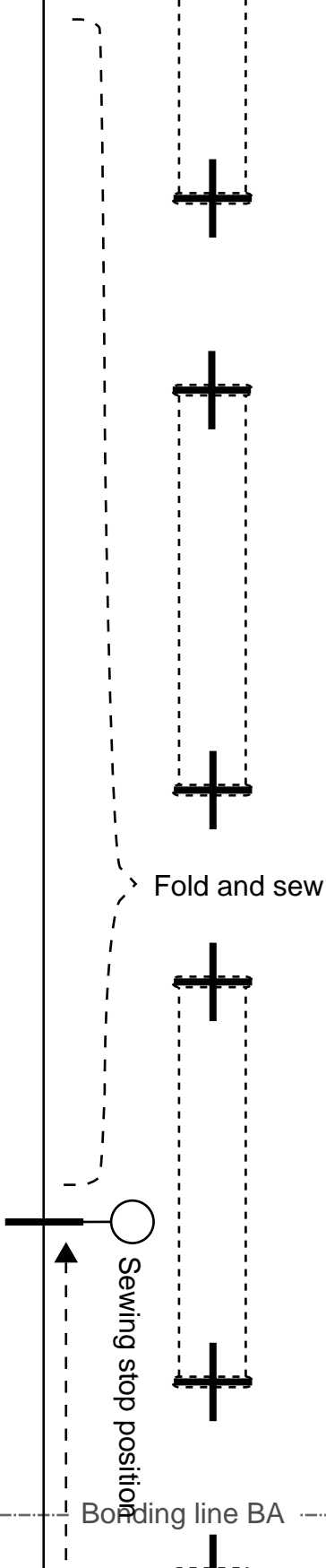

Bonding line BA

Fold and sew

Sewing stop position

# Chi

Bonding line Ab

S

SV

Bonding line Ba

Bonding line BA

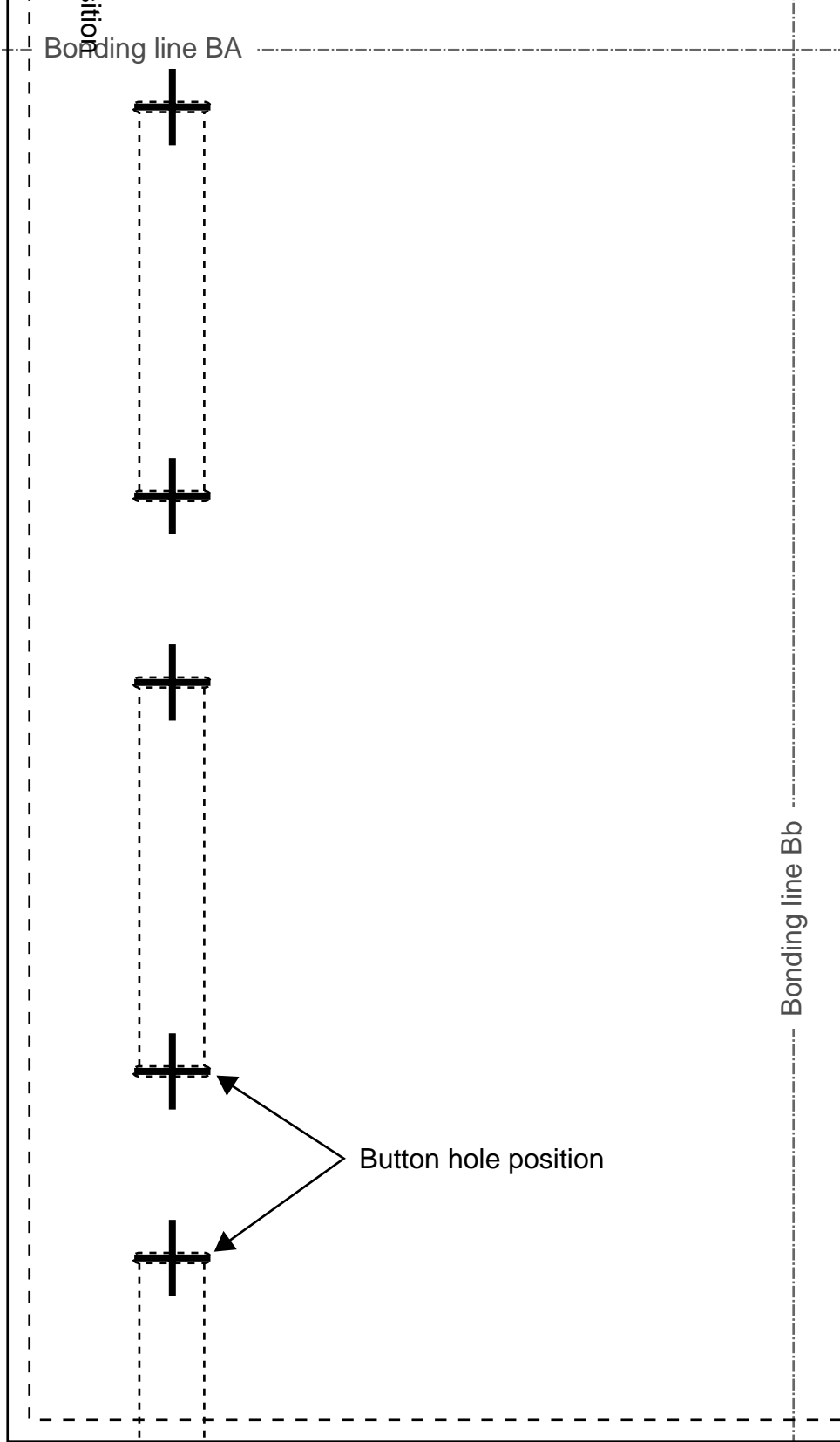

Bonding line Bb

Bonding line BB



Bonding line Ca

Bonding line BB

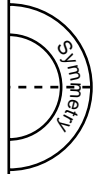
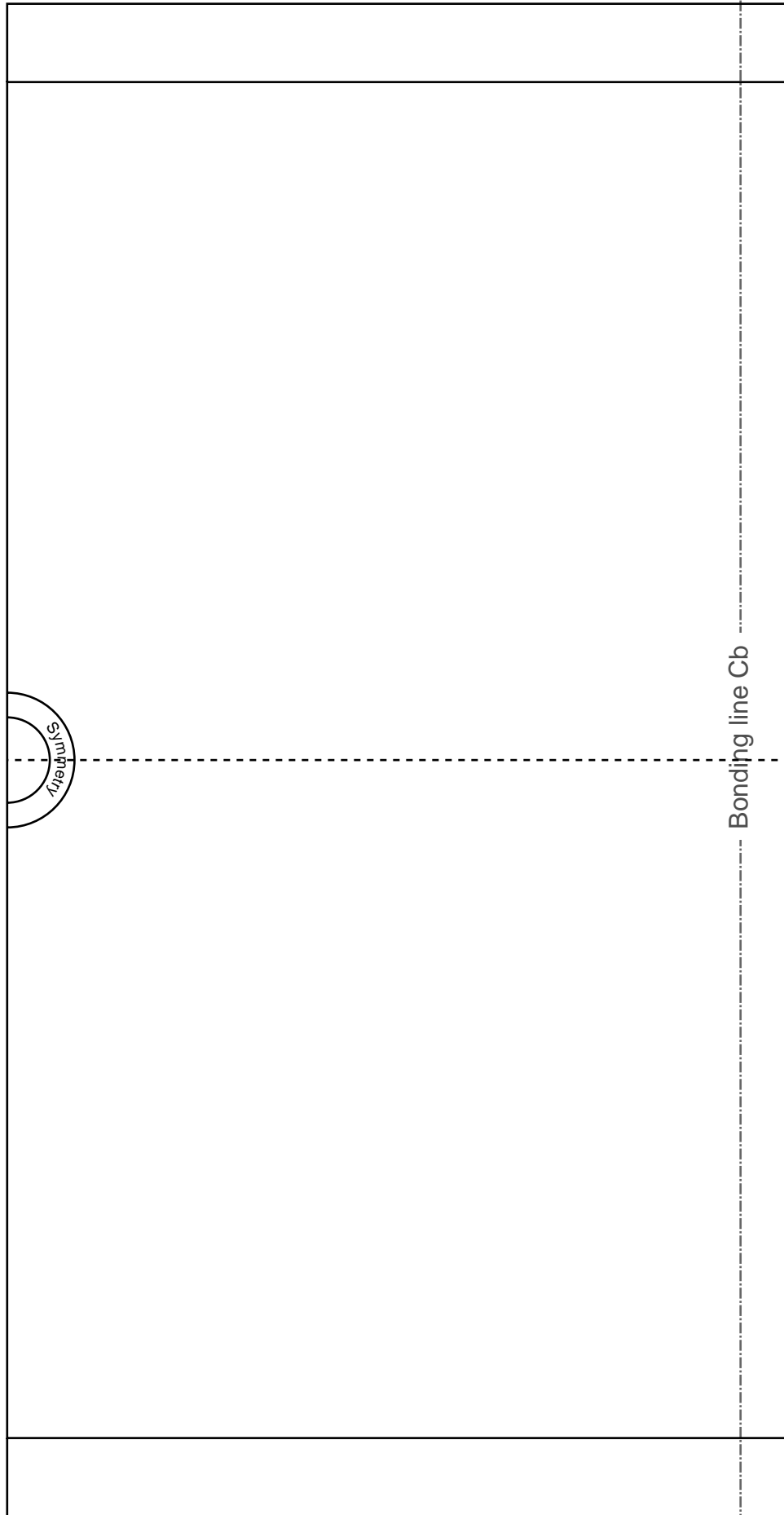

Bonding line BC

Bonding line Cb

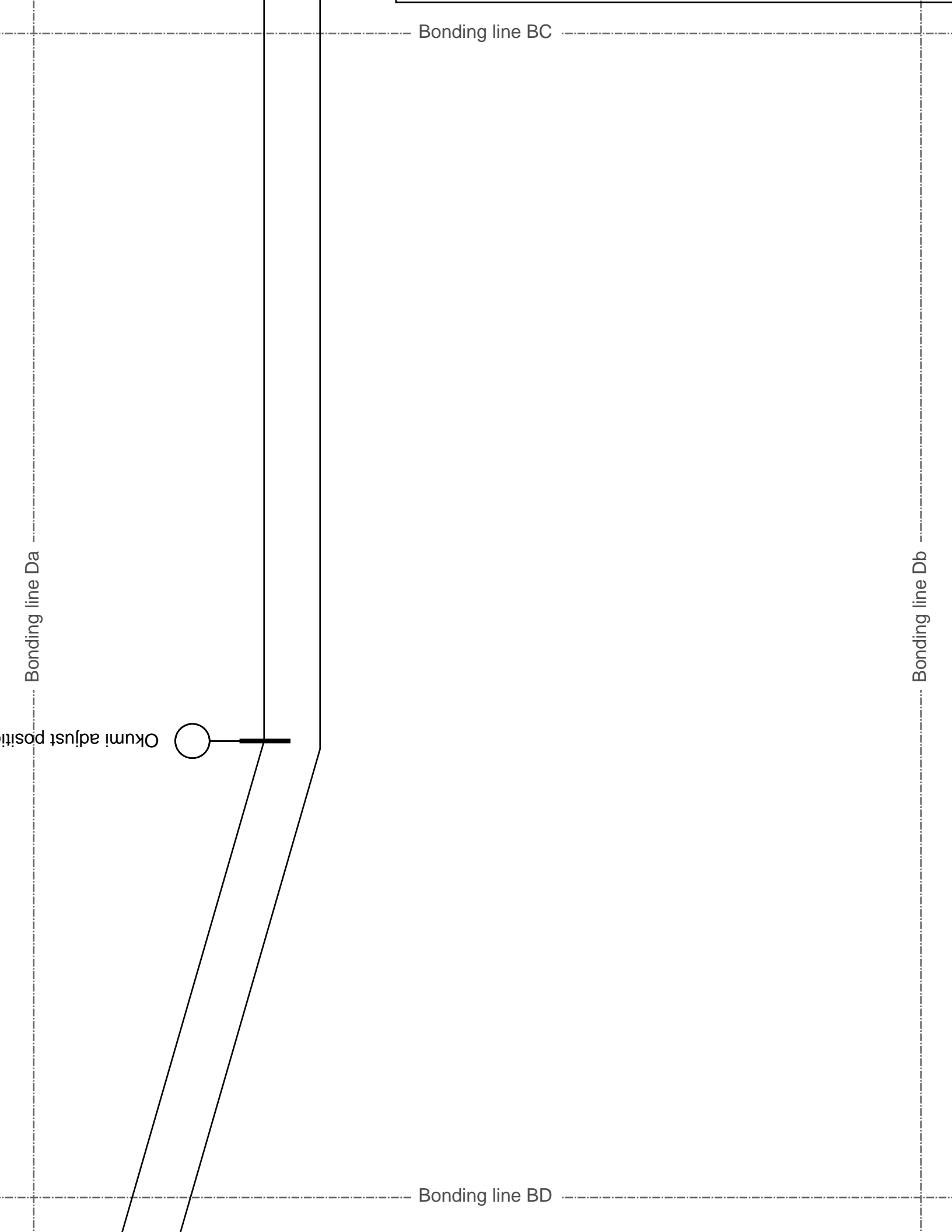

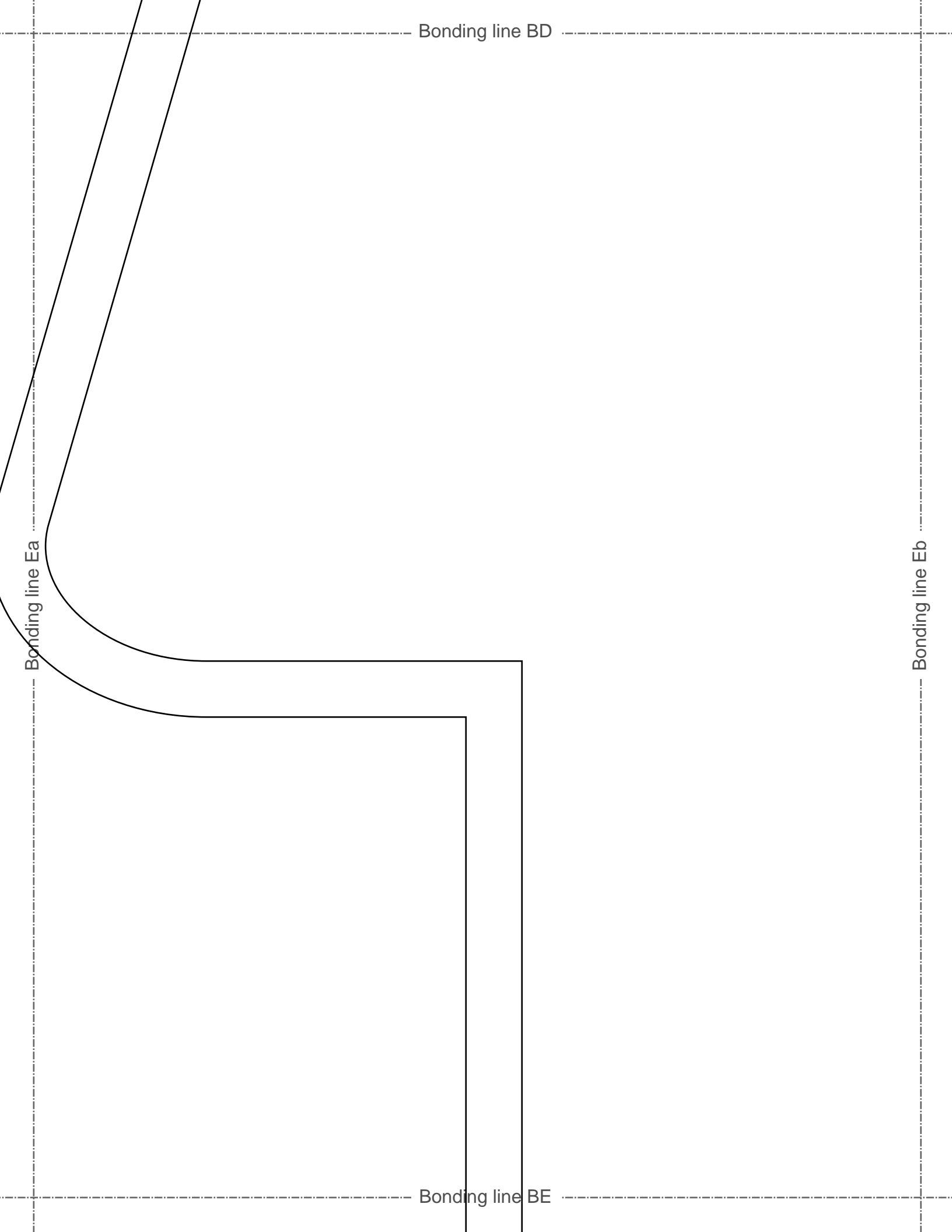

Bonding line BE

Bonding line Fa

Bonding line Fb

Bonding line BF

Bonding line BF

Bonding line Ga

Bonding line Gb

Bonding line BG



Bonding line BG

Bonding line Ha

Bonding line Hb

Bonding line BH

Bonding line BH

Bonding line Ia

Bonding line Ib



Bonding line Ab

# Children's

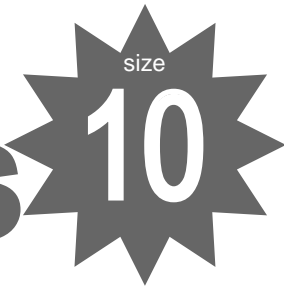

## Shrine Maiden(Miko) sleeve

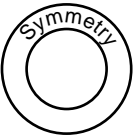

### two sheets

Bonding line Ac

Sleeve sewing stop



Bonding line CA

Bonding line CA

Grain Line

Fold and sew

Bonding line Bb

Bonding line Bc

**DRCOS**

SITE [http://dr-cos.info\(en\)](http://dr-cos.info(en)) [http://dr-cos.com\(jp\)](http://dr-cos.com(jp))  
MAIL [info@dr-cos.com](mailto:info@dr-cos.com)  
Twitter [@drcos\\_com](https://twitter.com/@drcos_com)  
facebook <https://www.facebook.com/drcoscom>

Seam allowance 1/2in.

Bonding line CB

# Children's <sup>size</sup> 10

Shrine Maiden(Miko)  
Inside collar  
one sheets

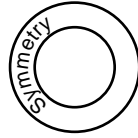

Bonding line CC

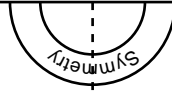

Bonding line Db

Bonding line Dc

# Children's <sup>size</sup> 10

Shrine Maiden(Miko)

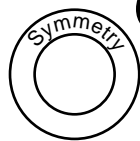

Outside collar  
one sheets

Bonding line CD

Bonding line Eb

Bonding line CD

Bonding line Ec

Bonding line CE

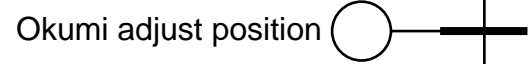

Bonding line CE

Bonding line Fb

Bonding line Fc



Seam allowance 1/2in.

Bonding line CF



Bonding line DB

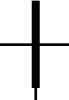

Okumi adjust position

Bonding line Cc

Bonding line Cd

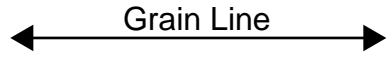

Grain Line

Bonding line DC

Bonding line EB

Bonding line Cd

Bonding line Ce

Bonding line EC

Bonding line FB

Bonding line Ce



Seam allowance 1/2in.

Bonding line FC

Bonding line Cf

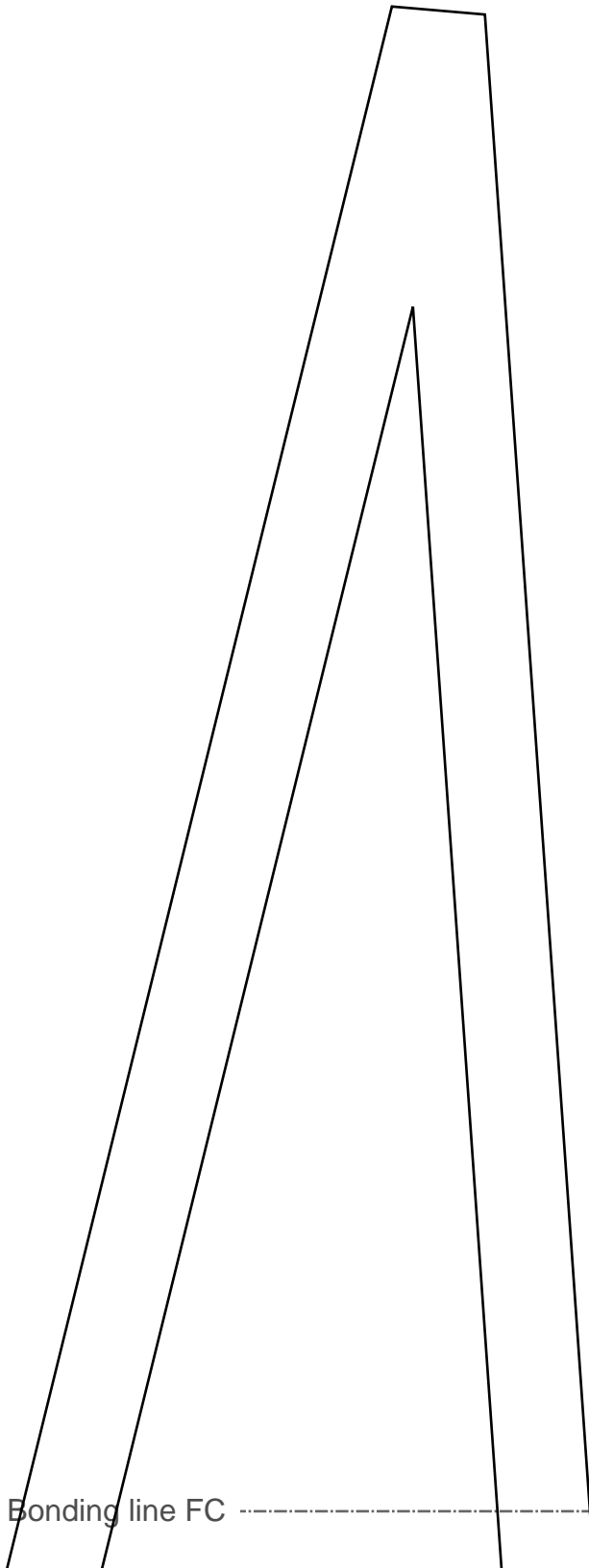

Bonding line FC

Bonding line De

Bonding line Df



Collar adjust position

Baste

Bonding line FD

# Children's size 10

Shrine Maiden(Miko)  
Okumi  
two sheets

Grain  
two sheets

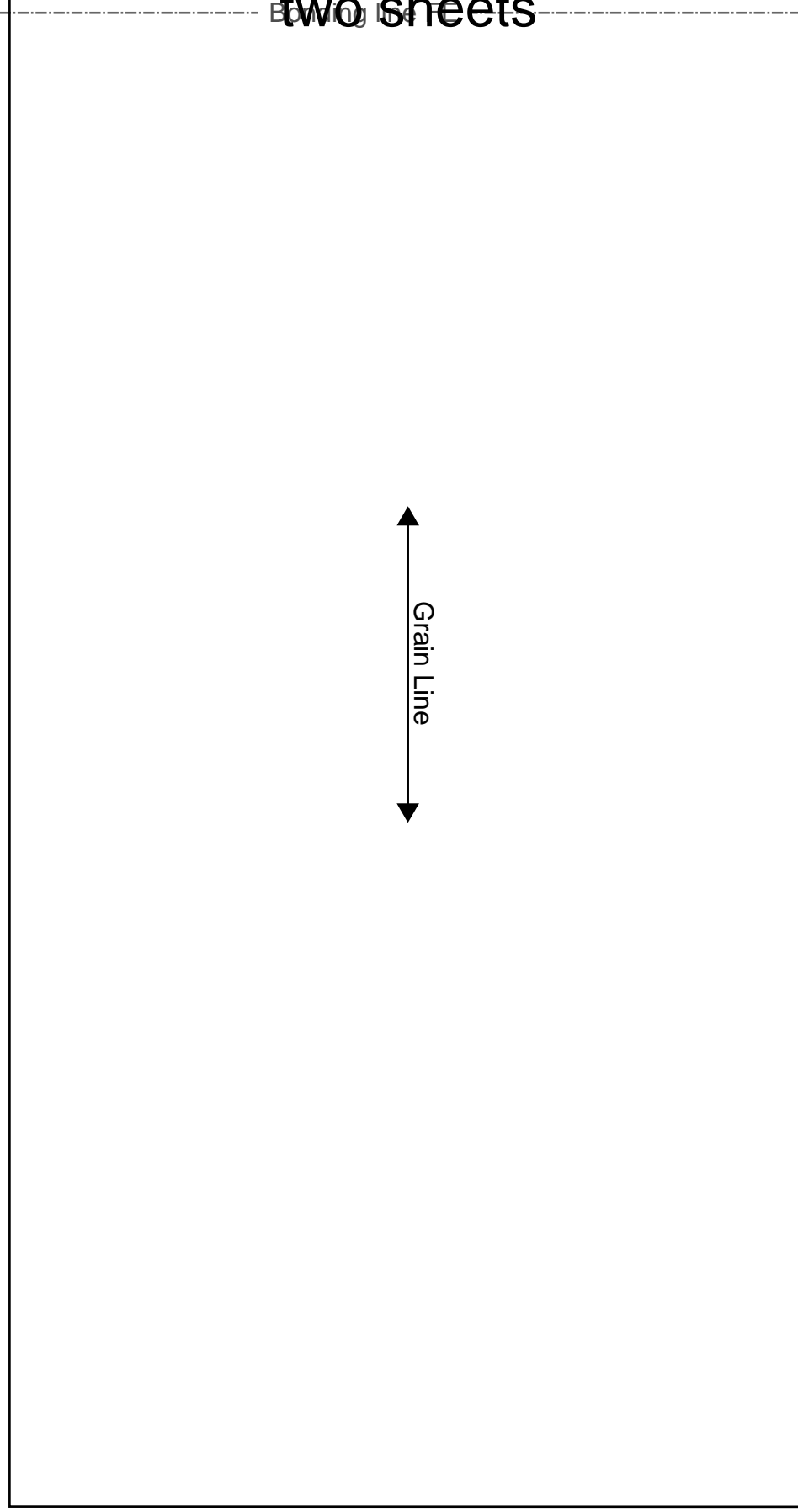

Bonding line Fe

Bonding line Ff

Seam allowance 1/2in.

Bonding line FF