

Children's

size 10

Cargopants
Front Bodice
cut two

Flap position

Bonding line AA

Bonding line AB

Bonding line Ba

ch end

Seam allowance 1/2in.

DRCOS
SITE <https://dr-cos.info/en> <https://dr-cos.com/jp>
MAIL info@dr-cos.com
Twitter <https://twitter.com/dr-cos>
Pinterest <https://www.pinterest.jp/dr-cos/info>

Baste



Bonding line AB

Dart

Dart

Stitch

Grain Line

DRCOS

SITE <https://drcos.info/en>, <https://drcos.com/jp>
MAIL info@drcos.com
TWITTER https://twitter.com/drcos_com
PINTEREST <https://www.pinterest.jp/drcosinfo>

Stitch

Bonding line Ca

Center line

Seam allowance 1/2in.

Bonding line AC

on

ts et

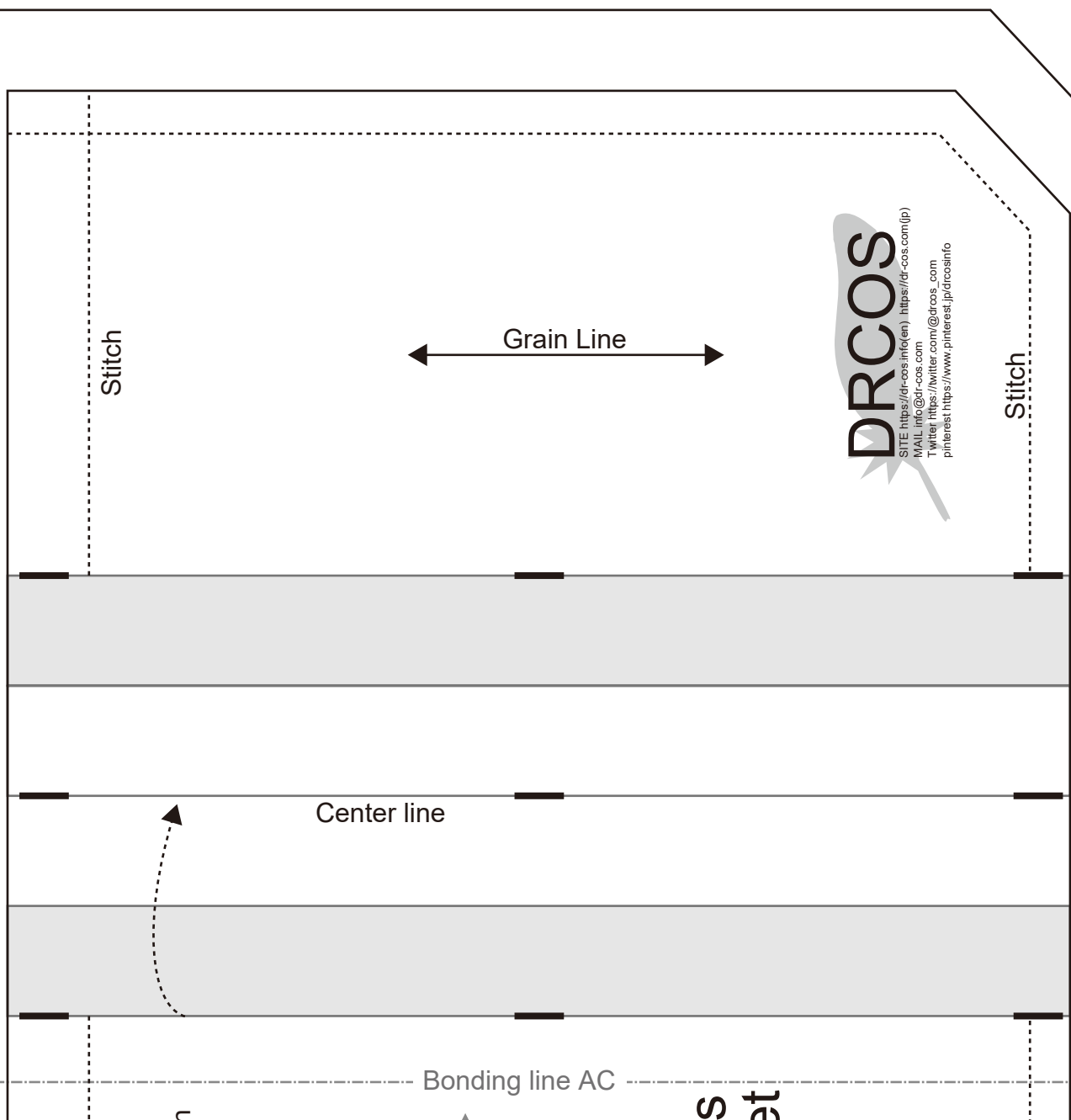
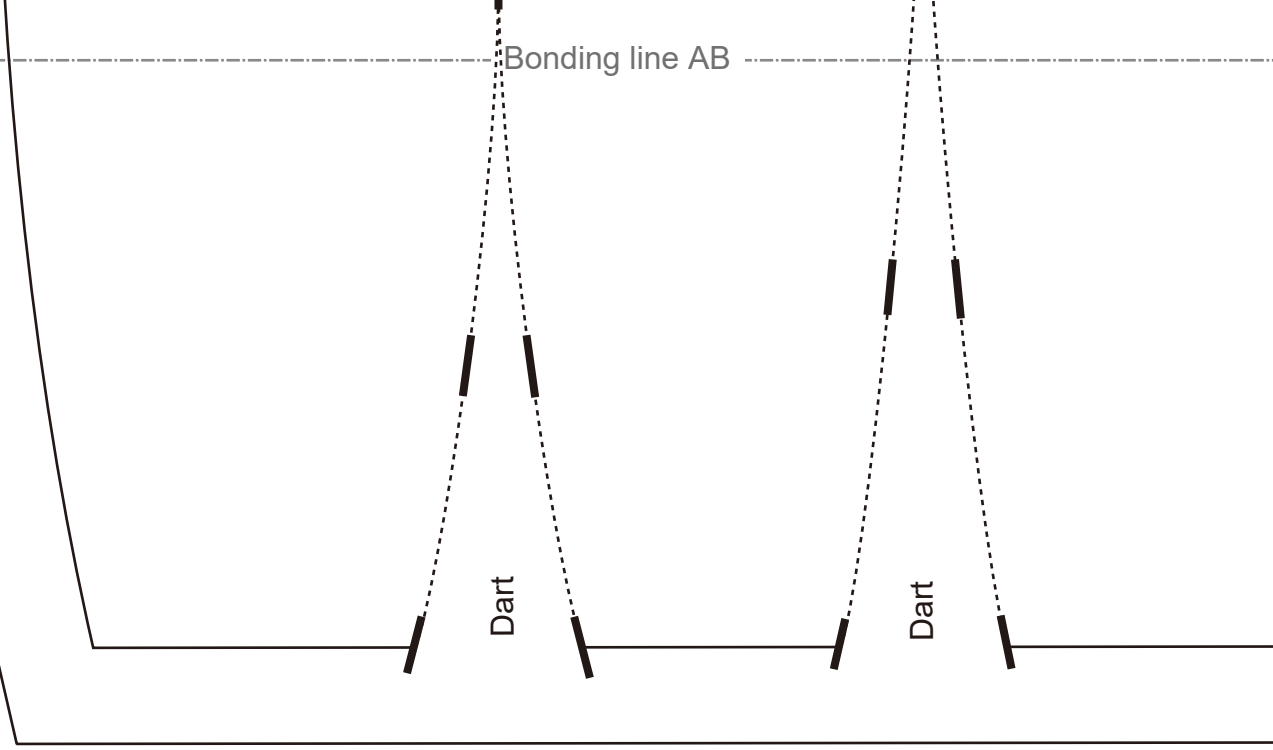

Bonding line AC

Button Position

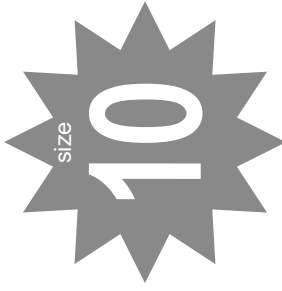

Cargopants
Side Pocket
cut two

DRCOS

SITE <https://drcos.info/en> <https://drcos.com/jp>
MAIL info@drcos.com
Twitter https://twitter.com/drcos_com
Pinterest <https://www.pinterest.jp/drcosinfo>



Cargopants
Fly extension
Interfacing
cut one

Grain Line

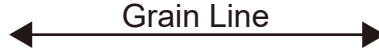

Crotch end



Bonding line Da

Grain Line



DRCOS

SITE <https://drcos.info/en> <https://drcos.com/jp>
MAIL info@drcos.com
Twitter https://twitter.com/drcos_com
Pinterest <https://www.pinterest.jp/drcosinfo>

Cargopants
Facing
Interfacing
cut one

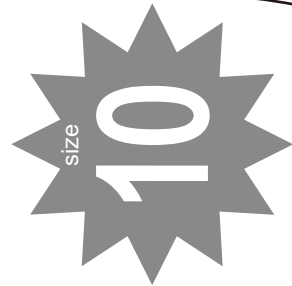

Crotch end



Seam allowance 1/2in.

Bonding line AD

Bonding line Aa

Bonding line BA

Bonding line Ab

Ch

Bonding line Ba

Bonding line BA

Bonding line Bb

Sew double-stitch

Crotch end

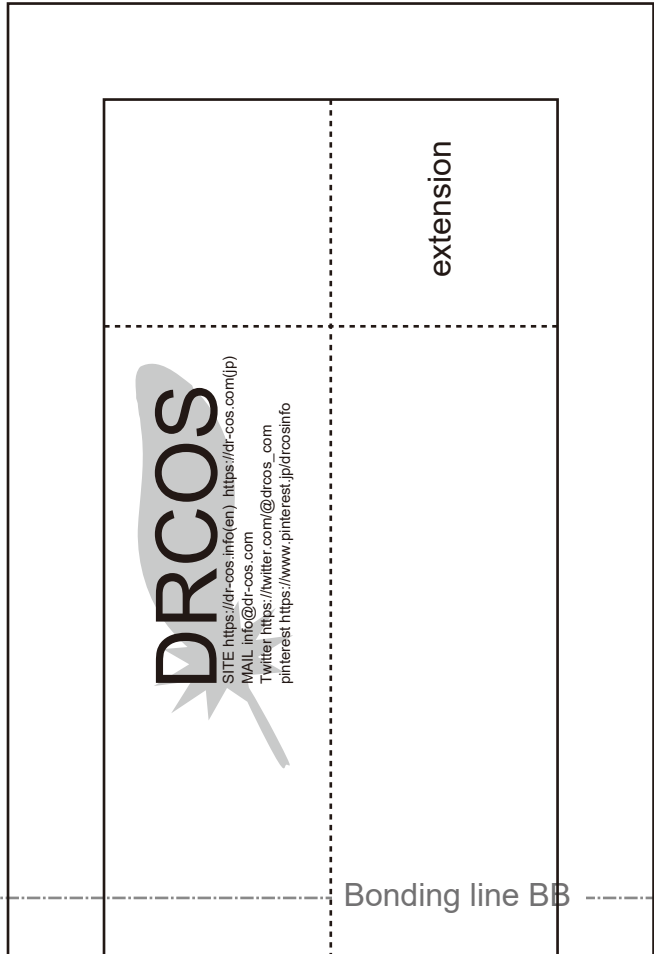

DRCOS

SITE <https://drcos.info/en>, <https://drcos.com/jp>
MAIL info@drcos.com
Twitter https://twitter.com/drcos_com
pinterest <https://www.pinterest.jp/drcosinfo>

extension

Bonding line BB

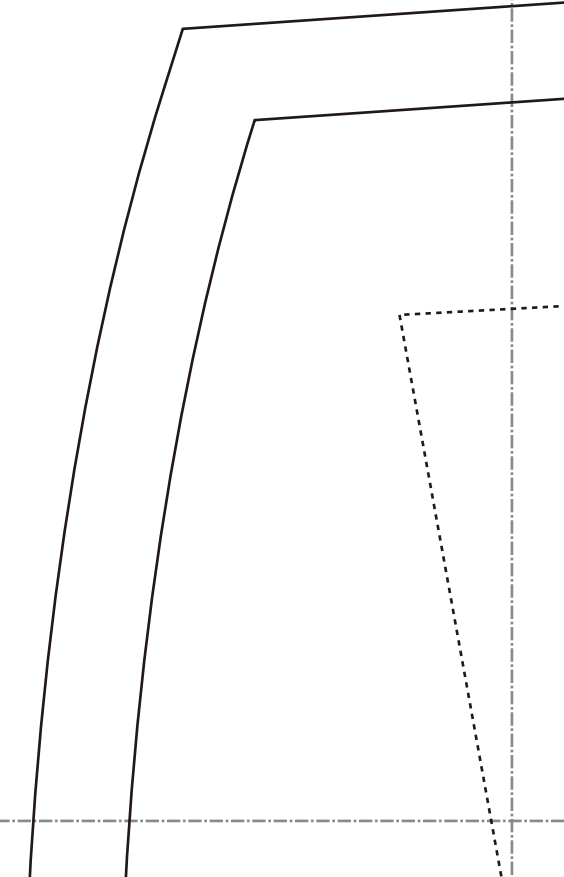
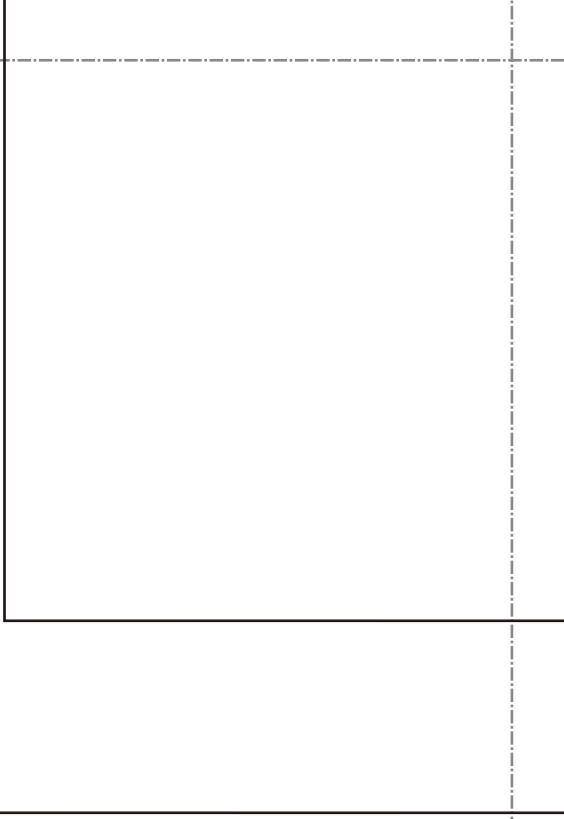

Seam allowance 1/2in.

Bonding line Ca

Bonding line BB

Cargopants Waist Band Interfacing cut one

Seam allowance 1/2in.

Seam allowance 1/2in.

Bonding line Cb



Bonding line BC

DRCOS
 SITE [https://dr-cos.info\(en\)](https://dr-cos.info(en)) <https://dr-cos.com/jp>
 MAIL info@dr-cos.com
 Twitter [@drcos_com](https://twitter.com/@drcos_com)
 pinterest <https://www.pinterest.jp/drcosinfo>

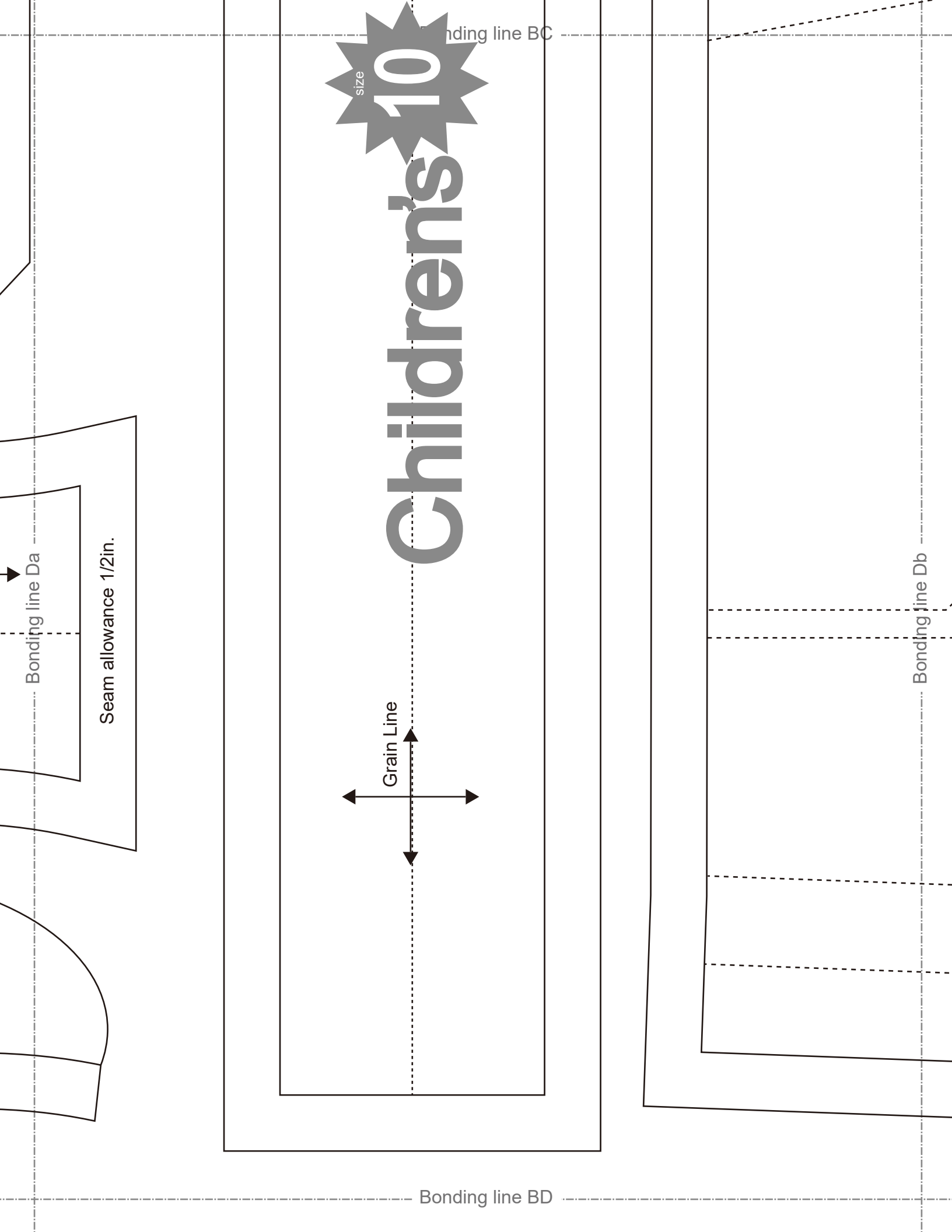

Bonding line BC

size

Children's 10

Grain Line

Bonding line Da

Seam allowance 1/2in.

Bonding line Db

Bonding line BD

DRCOS

SITE [https://dr-cos.info\(en\)](https://dr-cos.info(en)) [https://dr-cos.com\(jp\)](https://dr-cos.com(jp))

MAIL info@dr-cos.com

Twitter [@drcos_com](https://twitter.com/@drcos_com)

pinterest <https://www.pinterest.jp/drcosinfo>

Bonding line Ab

Children's ^{size} 10

Cargopants
Back Bodice
(lower part)
cut two

Seam allowance 1/2in.

Grain Line

Bonding line CA

Bonding line Ac

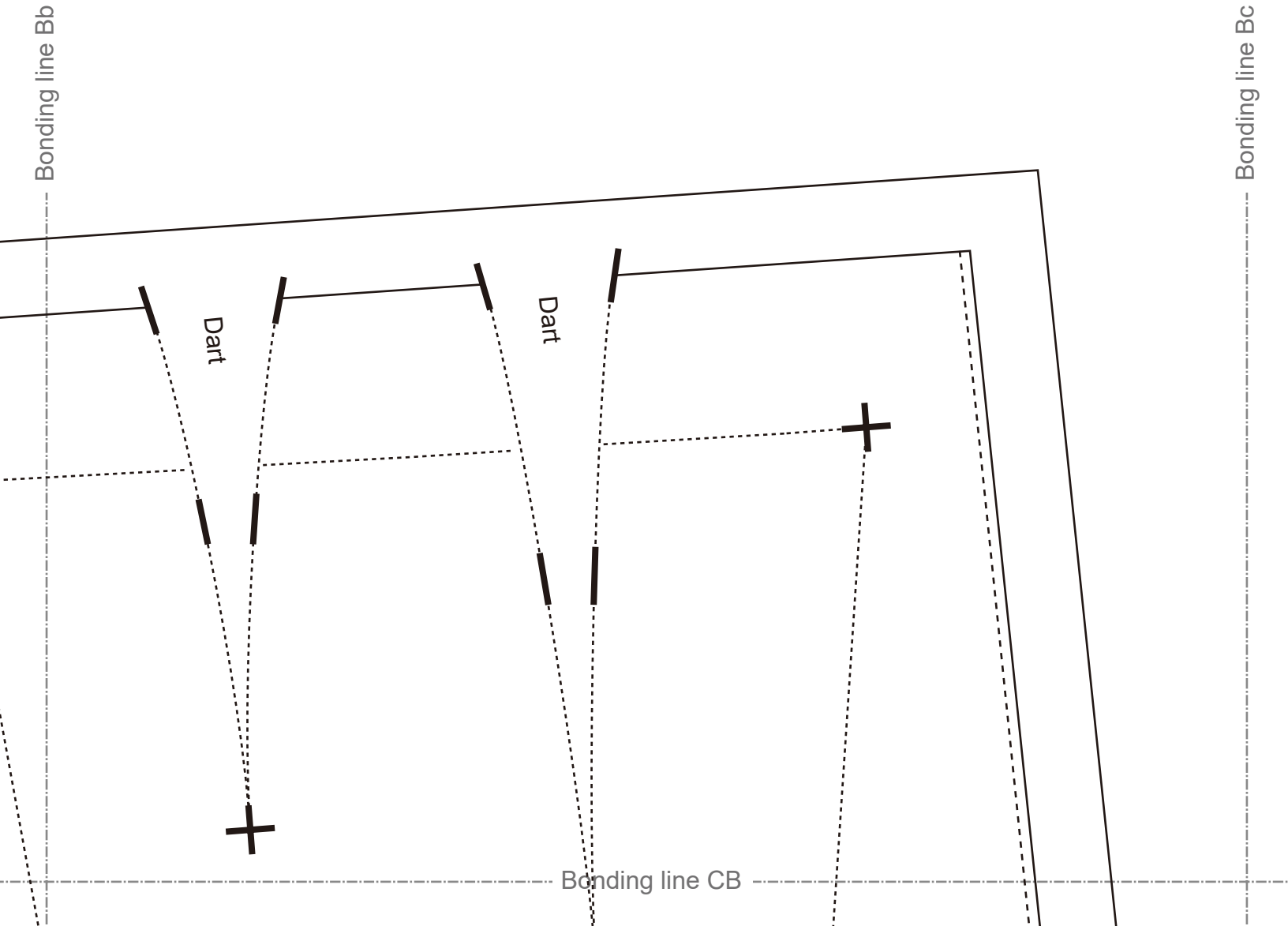
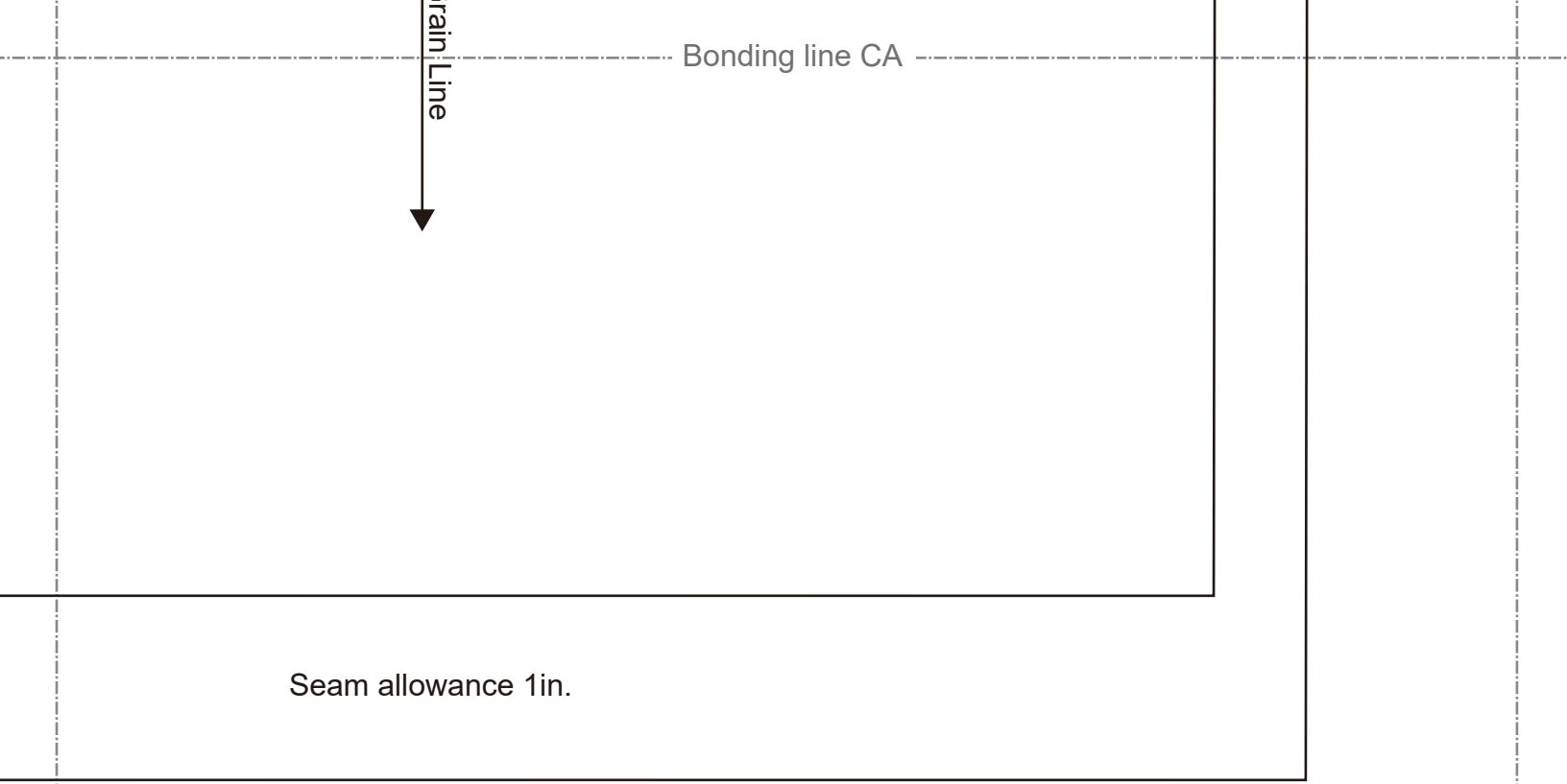

Bonding line CB



Pocket position



Bonding line Cb

Bonding line Cc
Sew double-stitch

DS

s//dr-cos.com(jp)

s_com
/dr-cosinfo

Children's

size

10

Cargopants

Back Bodice

Bonding line CC



Cargopants Back Bodice cut two

Bonding line CC



Grain Line

Bonding line Db



Bonding line Dc

Bonding line CD

Bonding line DB

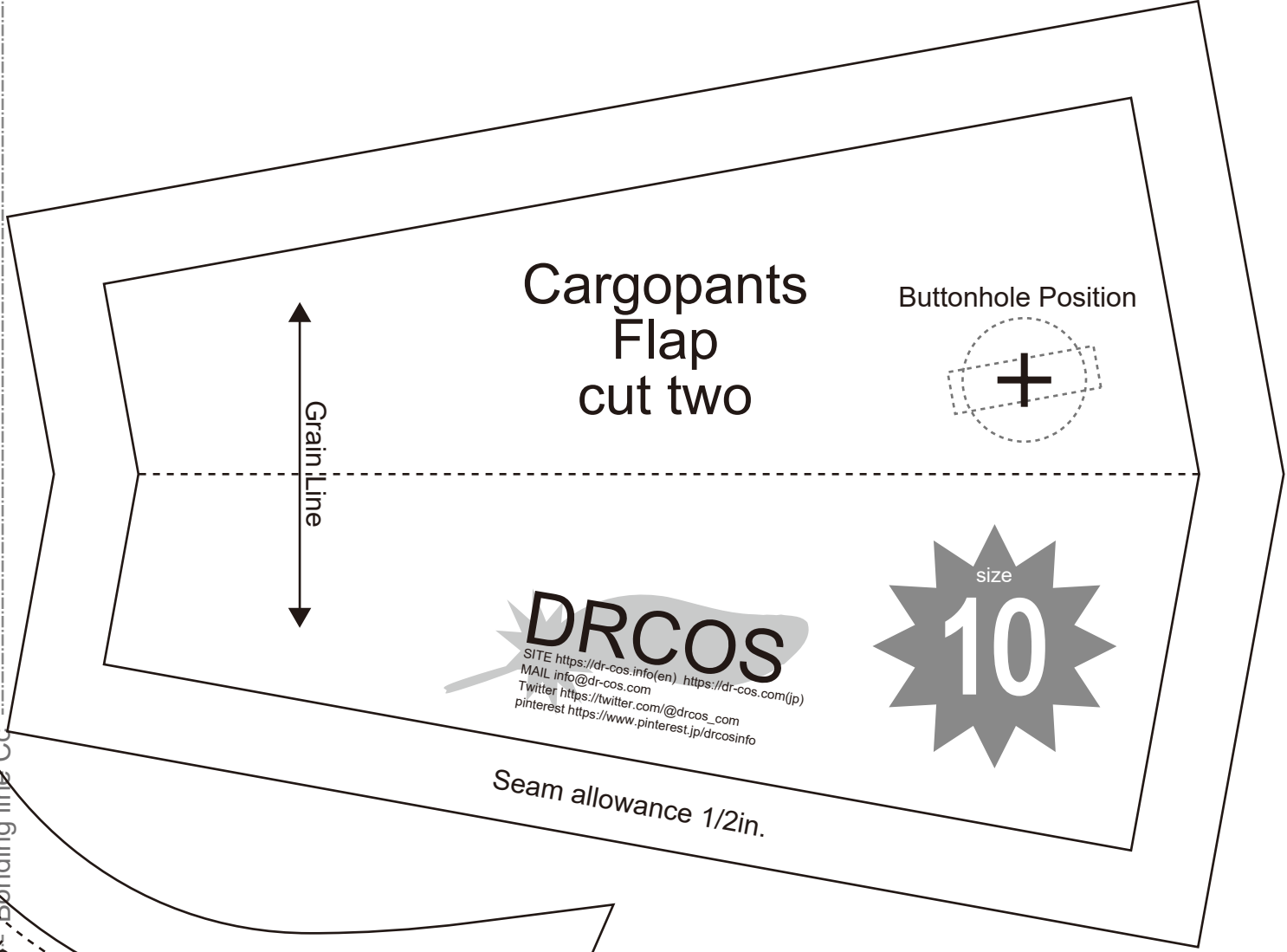

DRCOS
 SITE [https://dr-cos.info\(en\)](https://dr-cos.info(en)) [https://dr-cos.com\(jp\)](https://dr-cos.com(jp))
 MAIL info@dr-cos.com
 Twitter https://twitter.com/drcos_com
 pinterest <https://www.pinterest.jp/drcosinfo>



Bonding line Cc

Double-stitch

Bonding line Cd

Bonding line DC

Bonding line Dc

Bonding line DC

Seam allowance 1/2in.

SITE <https://drcos.info/en> [https://drcos.com\(jp\)](https://drcos.com(jp))
MAIL info@drcos.com
Twitter https://twitter.com/drcos_com
Pinterest <https://www.pinterest.jp/drcosinfo>

DRCOS

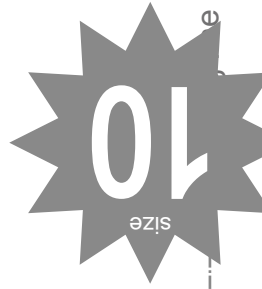

Bonding line DD

Bonding line EB

DRCOS

SITE: <https://drcos.info/en> | <https://drcos.com/jp>
MAIL: info@drcos.com
Twitter: https://twitter.com/drcos_com
Pinterest: <https://www.pinterest.jp/drcosinfo>

Children's
size 10

Cargopants
Back Pocket
cut two

Grain Line

Seam allowance 1/2in.

Bonding line Cd

Bonding line Ce

Seam allowance 1in.

Bonding line EC

line

Bonding line EC

Grain Line



Cargopants
Back Bodice
(lower part)
cut two

Children's

Bonding line De

Bonding line ED